



 **LGG INDUSTRIAL**

Solutions for:

The Rental Industry

Table of Contents

General Purpose Hose

Contractor Water Hose	4
Pressure Washer Hose	4
Pressure Washer Accessories	5
LPG Hose	6
Goodall® Elephant-Hide Premium LPG Transfer Hose	6
General Service Air Hose	7
Hose Reels	7
Jackhammer Hose	8
Bull Hose - Goodall® Hardrok - Yellow Wire Braid Air Hose	9
Jack Hammer Hose	10
AquaHammer Hose	11
Layflat Air Hose	11

Discharge Hose & Accessories

Blue PVC Layflat Discharge Hose	12
Gray PVC Layflat Discharge Hose	13
Brick Red PVC Layflat Discharge Hose	14
Snap-tite TPX Yellow Nitrile Layflat Discharge Hose	15
Mill Water Discharge Hose	16
Black or Yellow Nitrile Layflat Discharge Hose	18
Pin Lug Gaskets & Wrenches	19
Fog Nozzles	19
Goodall® Endurance Heavy-Duty Rubber Water Discharge Hose	20

Suction Hose

Green PVC Suction Hose	22
Green/Black EPDM Suction Hose	23
Orange Braided Clear Suction Hose	24
Goodall® Alligator SD Flexoline Rubber Water Suction/Discharge Hose	26
UHMW Corrugated Chemical Suction Discharge Hose	28
Goodall® Kemflex Chemical Hose	29
Water Pump Composite Hose	30
Oil Pump Composite Hose	31
Petroleum Tank Truck Hose	32
Oil S&D Hose With Built-in Flanges	33
Stainless Steel Metal Hose	34

Fittings	Camlock Fittings	35
	Camlock Accessories	36
	Universal Fittings - 2-Lug	37
	Universal Fittings - 4-Lug	37
	Ground Joint Fittings	38
	Whip Checks	39
	Bauer Fittings	40
	Flange Systems	42
	Stackable Storage Racks	42
	Bauer Fittings	43
	Strainers	44
	Grooved Fittings	45
	Flange Fittings	46
	Threaded Flanges	46
	Pipe Fittings	47
Valves	48	

Gasket Products	Flange Gaskets and Kits	49
	Gaskets	49

Ducting	AC Dehumidification	50
	AC Dehumidification Accessories	51
	Heater	52
	Heater Accessories	52
	Heater High-Temperature	53
	Layflat Poly	53

Miscellaneous Hose	Hydraulic Hose, Fittings & Adapters	54
	Hydraulic Crimpers and Accessories	54
	Hydraulic Mobile Crimper	54

Additional Information	Other Rental Industry Products & Solutions	55
-------------------------------	--	----

LGG Industrial is part of the SmartEquip network. We offer many product solutions for the rental industry via the SmartEquip portal. Contact your nearest LGG Industrial location for more information or email us at rental@lggind.com.



Contractor Water Hose

- Application:** Heavy-duty water hose engineered to remain flexible. Designed for professional-grade contractor use.
- Temperature Range:** -40°F to +180°F (-40°C to +82°C)
- Tube:** EPDM
- Reinforcement:** Spiral polyester yarn
- Cover:** Black EPDM - heat, ozone, and sunlight resistant
- Note:** Popular assemblies shown below – additional sizes and assemblies are available upon request.



LGG Part Number	Hose Size	End - 1	End - 2	Attachment Method	Max Hose WP PSI	Max Assy WP PSI
10302956	5/8" x 50'	M-GHT	F-GHT	Crimped	150	150
10298863	3/4" x 50'	M-GHT	F-GHT	Crimped	150	150

NOTE: Maximum WP of assembly is temperature-dependent.

Pressure Washer Hose

- Application:** High-pressure cleaning equipment hose assemblies rated for hot and cold applications. Excellent ozone, abrasion, and weather resistance. Not recommended for steam service.
- Temperature range:** -40°F to +300°F (-40°C to +149°C)
- Tube:** Water-resistant synthetic rubber
- Reinforcement:** One layer of high-strength tensile steel wire braid 4000 PSI and two layers for 6000 PSI
- Cover:** Black ozone and weather resistant synthetic rubber
- Standards:** Exceeds EN857
- Note:** Popular assemblies shown below – additional sizes and assemblies are available upon request.



LGG Part Number - Black	LGG Part Number - Blue	Hose Size	End - 1	End - 2	Attachment Method	Max Hose WP PSI	Max Assy WP PSI
10265707	10600118	3/8" x 50'	M-QC	F-QC	Crimped	4000	4000
10364301	10600119	3/8" x 50'	M-QC	F-QC	Crimped	6000	6000

NOTE: Maximum WP of assembly is temperature-dependent.

Pressure Washer Accessories

LGG Part Number	Description	
10435057	32" STAINLESS STEEL LANCE FOR 4000 PSI PRESSURE WASHERS	
10600184	1/4" X 24" PRESSURE WASHER EXTENSION WAND WITH MXF QUICK DISCONNECTS	
10600185	1/4" X 36" PRESSURE WASHER EXTENSION WAND WITH MXF QUICK DISCONNECTS	
10348042	PRESSURE WASHER SPRAY GUN 4200 PSI WITH QUICK DISCONNECT	



3/8" Brass Coupler

LGG Part Number

10295717



3/8" Steel Plug

LGG Part Number

10038334



3/8" Brass Plug

LGG Part Number

10220836

Pressure Washer



Durable, easy to use and built to last, Generac's rugged commercial power washer features a professional grade triplex pump and durable, welded roll-cage style frame that protects both the engine and pump. Its 12 in. pneumatic wheels and exclusive professional-grade spray gun complement the powerful 420cc Generac OHV horizontal shaft engine and pump.

LGG Part Number

10435056



Spray Tip Pack

LGG Part Number

10435053

LPG Hose

Application: Specifically designed for residential and commercial delivery/transfer of liquid propane gas, LPG dispensing and LPG portable heaters. Excellent cold weather flexibility, a smooth cover for low drag resistance, and a low extraction tube to reduce contamination. The hose meets UL, CGA and DOT requirements.

Temperature Range: -40°F to +180°F (-40°C to +82°F)

Tube: Nitrile Synthetic Rubber

Reinforcement: 4 Textile Spiral Reinforced

Cover: Synthetic Rubber

Note: This hose is intentionally pin-pricked for safety reasons. Butane-Propane hose must be used in an open, well-ventilated environment. Popular assemblies shown below – additional sizes and assemblies are available upon request.



LGG Part Number	Hose Size	End - 1	End - 2	Attachment Method	Max Hose WP PSI	Max Assy WP PSI
10107059	1/2" x 50'	Male NPT	Male NPT	Crimped	350	350
10185386	3/4" x 50'	Male NPT	Male NPT	Crimped	350	350
10207058	1" x 50'	Male NPT	Male NPT	Crimped	350	350
10600701	1-1/4" x 50'	Male NPT	Male NPT	Crimped	350	350

NOTE: Maximum WP of assembly is temperature-dependent.

Goodall® Elephant-Hide Premium LPG Transfer Hose

Application: Premium LPG transfer hose for demanding conditions. Superior high abrasion-resistant cover. Designed specifically for tank truck service. Ideal for trailer-to-storage use. Approved to UL 21.

Temperature Range: -40°F to +180°F (-40°C to +82°C)

Tube: Smooth and seamless extruded nitrile (NBR). Developed specifically to resist tube cracking caused by the transfer of LPG.

Reinforcement: Multiple braids of high-tensile textile reinforcement

Cover: Superior abrasion-resistant proprietary neoprene (CR). Pin-pricked. Compounded to resist cover cracking from exposure to weather and ozone conditions.

Note: Popular assemblies shown below – additional sizes and assemblies are available upon request.



LGG Part Number	Hose Size	End - 1	End - 2	Attachment Method	Max Hose WP PSI	Max Assy WP PSI
10425703	1-1/2" x 25'	Male NPT	Male NPT	Crimped	350	350
10344951	2" x 25'	Male NPT	Male NPT	Crimped	350	350

NOTE: Maximum WP of assembly is temperature-dependent.

General Service Air Hose

Application: This tough, versatile factory-coupled air hose is specifically designed to stand up to the harsh working conditions found on most construction sites and in industrial environments.

Temperature Range: -40°F to +200°F (-40°C to +93°C)

Tube: EPDM

Reinforcement: 4 spiral polyester yarn

Cover: EPDM high quality abrasion and ozone resistant

Note: Popular assemblies shown below – additional sizes and assemblies are available upon request.



LGG Part Number	Hose Size	End - 1	End - 2	Attachment Method	Max Hose WP PSI	Max Assy WP PSI
10301347	1/4" x 25'	Male NPT	Male NPT	Crimped	300	300
10302275	1/4" x 50'	Male NPT	Male NPT	Crimped	300	300

LGG Part Number	Hose Size	End - 1	End - 2	Attachment Method	Max Hose WP PSI	Max Assy WP PSI
10072864	3/8" x 25'	1/4" Male NPT	1/4" Male NPT	Crimped	300	300
10182336	3/8" x 50'	1/4" Male NPT	1/4" Male NPT	Crimped	300	300

LGG Part Number	Hose Size	End - 1	End - 2	Attachment Method	Max Hose WP PSI	Max Assy WP PSI
10243981	1/2" x 25'	1/2" Male NPT	1/2" Male NPT	Crimped	300	300

NOTE: Maximum WP of assembly is temperature-dependent.

Hose Reels

LGG Part Number	Hose ID	Hose Length	Hose Model	Reel Model #	Max Assy WP PSI
10011573	1/2"	50'	SH-N	300	300
10327146	1/2"	100'	SH-N	300	300
10252917	3/4"	50'	SH-N	300	300
10290283	3/4"	100'	SLP	300	300



Model SH-N



Model SLP

Bull Hose – Heavy Duty Wire Braid Air Hose

Application: A robust hose for oil-laden compressed air. For use in industrial, construction, and surface mining applications requiring steel wire-braided hose with an oil-resistant tube and abrasion-resistant cover.

Temperature Range: -40°F to +212°F (-40°C to +100°C)

Tube: Black EPDM rubber, suitable for oil-laden air

Reinforcement: Multiple high-tensile brass-plated steel wire braids

Cover: Yellow EPDM rubber, resistant to abrasion, ozone and weather, cloth impression

Note: Popular assemblies shown below– additional sizes and assemblies are available upon request.



LGG Part Number	Hose Size	End - 1	End - 2	Attachment Method	Max Hose WP PSI	Max Assy WP PSI
10425731	1" x 50'			4 bolt clamp	600	600
10425884	1" x 100'			4 bolt clamp	600	600
10425881	1-1/2" x 50'			4 bolt clamp	600	600
10425754	1-1/2" x 100'			4 bolt clamp	600	600
10600450	2" x 25'			4 bolt clamp	600	600
10425819	2" x 50'			4 bolt clamp	600	600
10425861	2" x 100'			4 bolt clamp	600	600
10425766	3" x 25'			4 bolt clamp	600	500
10425743	3" x 50'			4 bolt clamp	600	500

NOTE: Maximum WP of assembly is temperature-dependent.

LGG Part Number	Hose Size	End - 1	End - 2	Attachment Method	Max Hose WP PSI	Max Assy WP PSI
10425808	1" x 50'			Crimped	600	600
10425889	1" x 100'			Crimped	600	600
10425712	1-1/2" x 50'			Crimped	600	600
10425705	1-1/2" x 100'			Crimped	600	600
10425707	2" x 50'			Crimped	600	600
10425850	2" x 100'			Crimped	600	600
10425752	3" x 25'			Crimped	600	600
10425781	3" x 50'			Crimped	600	600

NOTE: Maximum WP of assembly is temperature-dependent.

LGG Part Number	Hose Size	End - 1	End - 2	Attachment Method	Max Hose WP PSI	Max Assy WP PSI
10160949	2" x 25'			4 bolt clamp	600	150
10125776	2" x 50'			4 bolt clamp	600	150

NOTE: Maximum WP of assembly is temperature-dependent.

Bull Hose - Goodall® Hardrok - Yellow Wire Braid Air Hose

Application: Superior-performing heavy-duty Goodall® Hardrok air hose. The Goodall® Hardrok hose is kink-resistant but still very flexible. Excellent in bull-line service. Ideal for the transfer of high-temperature air. May also be used as a robust oil-transfer hose.

Temperature Range: -40°F to +268°F (-40°C to +131°C)

Tube: Extruded, smooth proprietary NBR compound. Exceptional resistance to heat and oil.

Reinforcement: Multiple braids of high-tensile steel wire. Braided with brass-plated wire for corrosion resistance.

Cover: Yellow, smooth proprietary SBR compound. Extreme abrasion resistance and excellent weather, ozone, and petroleum resistance.

Note: Popular assemblies shown below – additional sizes and assemblies are available upon request.



LGG Part Number	Hose Size	End - 1	End - 2	Attachment Method	Max Hose WP PSI	Max Assy WP PSI
10425740	2" x 25'			Crimped	600	600
10425883	2" x 50'			Crimped	600	600

NOTE: Maximum WP of assembly is temperature-dependent.

CRN APPROVED FOR CANADA

LGG Part Number	Hose Size	End - 1	End - 2	Attachment Method	Max Hose WP PSI	Max Assy WP PSI
10529163	2" x 25'			Crimped	600	600
10529910	2" x 50'			Crimped	600	600

NOTE: Maximum WP of assembly is temperature-dependent.



Jackhammer Hose

Application: Quality hose for air tool applications on construction sites. Tough, durable, and ready for hard work. Reliable and safe crimped steel "Universal Coupling." Available with an EPDM tube and cover that handles heat, ozone, and weather cracking better than other compounds.

Temperature Range: -40°F to +200°F (-40°C to +93°C)

Tube: EPDM

Reinforcement: 4 spiral polyester yarn



Cover: EPDM - Very good heat, abrasion, weather and ozone resistance

Oil Resistance: Limited

Note: Also available in 1" diameter – other sizes, colors, and fittings are available. Contact your nearest LGG Industrial location more information.





United States Specifications

LGG Part Number	Hose Size	End - 1	End - 2	Attachment Method	Max Hose WP PSI	Max Assy WP PSI	Color
10600197	3/4" x 50'			Crimped	300	150	Red
10154733	3/4" x 50'	Universal	Universal	Crimped	300	150	Blue
10099445	3/4" x 50'	Universal	Universal	Crimped	300	150	Yellow
10233936	1" x 50'	Universal	Universal	Crimped	200	150	Red

NOTE: Maximum WP of assembly is temperature-dependent.



Canada Specifications

LGG Part Number	Hose Size	End - 1	End - 2	Attachment Method	Max Hose WP PSI	Max Assy WP PSI	Color
10600170	3/4" x 50'			Crimped	300	300	Red
10529913	3/4" x 50'	Thor	Thor	SS Banded	300	300	Yellow
10529911	3/4" x 50'	Thor	Thor	SS Banded	400	300	Yellow

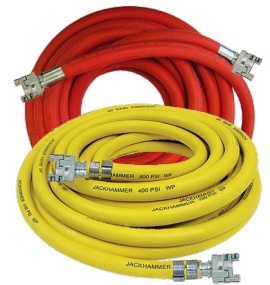
NOTE: Maximum WP of assembly is temperature-dependent.



Canada Specifications

LGG Part Number	Hose Size	End - 1	End - 2	Attachment Method	Max Hose WP PSI	Max Assy WP PSI	Color
10529912	3/4" x 50'			SS Banded	300	300	Yellow

NOTE: Maximum WP of assembly is temperature-dependent.



AquaHammer Hose

- Application:** Dual air/water jackhammer factory assemblies are crimped with high-quality universal couplings and MNPT fittings. It is designed for silica dust suppression and to help contractors meet OSHA Respirable Crystalline Silica Standard.
- Temperature Range:** -40°F to +210°F (-40°C to +99°C)
- Tube:** EPDM, ARPM Class C (Limited Oil Resistance)
- Reinforcement:** Spiral synthetic yarn
- Cover:** EPDM, ARPM Class C (Limited Oil Resistance)





LGG Part Number	Hose Type	Hose Size	End - 1	End - 2	Attachment Method	Max Assy WP PSI
10600286	Air (Green)	3/4" x 50'	Universal	Universal	Crimped	200
	Water (Blue)	3/8" x 50'	3/8" MNPT (Brass)	3/8" MNPT (Brass)	Crimped	200

NOTE: Maximum WP of assembly is temperature-dependent.

Layflat Air Hose

- Application:** Layflat hose designed for compressed air at high working pressures while still offering a light-weight solution. Easy to deploy and store.
- Temperature Range:** Max + 230°F (+110°C)
- Tube:** Thermoplastic polyurethane (TPU)
- Reinforcement:** High tensile polyester weaves
- Cover:** Double jacket hose solution ensuring high burst pressure, puncture resistance and flexibility. Excellent abrasion resistance.



LGG Part Number	Hose Size	End - 1	End - 2	Attachment Method	Max Hose WP PSI	Max Assy WP PSI
10600459	2" x 25'			Crimped	635	550
10252732	2" x 50'	Ground Joint w/spud	Ground Joint w/spud	Crimped	635	550
10600460	3" x 25'	Ground Joint w/spud	Ground Joint w/spud	Crimped	635	550
10600335	3" x 50'	Ground Joint w/spud	Ground Joint w/spud	Crimped	635	550

NOTE: Maximum WP of assembly is temperature-dependent.

Blue PVC Layflat Discharge Hose

Application: Economy grade, PVC hose for portable pump and irrigation use. Layflat hose for easy coiling and handling. Used in rental, constuction, mining, dewatering, agriculture, marine, and general water discharge.

Temperature Range: 23°F to +131°F (-5°C to +55°C)



Tube: PVC

Reinforcement: Polyester yarn



Cover: Blue or Gray PVC

Note: Popular assemblies shown below – additional sizes and assemblies are available upon request.



LGG Part Number	Hose Size	End - 1	End - 2	Attachment Method	Max Hose WP PSI	Max Assy WP PSI
10116362	2" x 50'			SS Banded	80	80
10600730	2" X 100'	Fem Cam Alum	Male Cam Alum	SS Banded	80	80
10147722	3" x 50'	Fem Cam Alum	Male Cam Alum	SS Banded	70	70
10600731	3" X 100'	Fem Cam Alum	Male Cam Alum	SS Banded	70	70
10013414	4" x 50'	Fem Cam Alum	Male Cam Alum	SS Banded	70	70
10600732	4" X 100'	Fem Cam Alum	Male Cam Alum	SS Banded	70	70
10199277	6" x 50'	Fem Cam Alum	Male Cam Alum	SS Banded	50	50
10600733	6" X 100'	Fem Cam Alum	Male Cam Alum	SS Banded	50	50





LGG Part Number	Hose Size	End - 1	End - 2	Attachment Method	Max Hose WP PSI	Max Assy WP PSI
10254912	2" x 50'			SS Banded	80	80
10600734	2" X 100'	Fem NPSH Pin Lug	Male NPSH	SS Banded	80	80
10130158	3" x 50'	Fem NPSH Pin Lug	Male NPSH	SS Banded	70	70
10600735	3" X 100'	Fem NPSH Pin Lug	Male NPSH	SS Banded	70	70
10285661	4" x 50'	Fem NPSH Pin Lug	Male NPSH	SS Banded	70	70
10600736	4" X 100'	Fem NPSH Pin Lug	Male NPSH	SS Banded	70	70
10263002	6" x 50'	Fem NPSH Pin Lug	Male NPSH	SS Banded	50	50
10600737	6" X 100'	Fem NPSH Pin Lug	Male NPSH	SS Banded	50	50





NOTE: Maximum WP of assembly is temperature-dependent.

Gray PVC Layflat Discharge Hose

LGG Part Number	Hose Size	End - 1	End - 2	Attachment Method	Max Hose WP PSI	Max Assy WP PSI
10600113	2" x 50'			SS Banded	60	60
10600114	3" x 50'	Fem NPSH Pin	Lug Male NPSH	SS Banded	60	60
10600115	4" x 50'	Fem NPSH Pin	Lug Male NPSH	SS Banded	60	60



LGG Part Number	Hose Size	End - 1	End - 2	Attachment Method	Max Hose WP PSI	Max Assy WP PSI
10600126	1-1/2" x 50'			SS Banded	60	60



NOTE: Maximum WP of assembly is temperature-dependent.



Brick Red PVC Layflat Discharge Hose

Application: A more rugged version of the blue and gray PVC layflat discharge hoses, designed for use where higher working pressures are required. Layflat hose for easy coiling and handling. Used in rental, construction, mining, etc.

Temperature Range: -5°F to +170°F (-21°C to +77°C)



Tube and Cover: 3-ply polyester yarns. Both tube and cover are extruded simultaneously to obtain maximum bonding.

Note: Popular assemblies shown below – additional sizes and assemblies are available upon request.

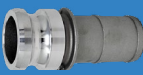



LGG Part Number	Hose Size	End - 1	End - 2	Attachment Method	Max Hose WP PSI	Max Assy WP PSI
10425892	2" x 50'			SS Banded	150	150
10600738	2" X 100'	Fem Cam Alum	Male Cam Alum	SS Banded	150	150
10425860	3" x 50'	Fem Cam Alum	Male Cam Alum	SS Banded	150	150
10600739	3" X 100'	Fem Cam Alum	Male Cam Alum	SS Banded	150	150
10425811	4" x 50'	Fem Cam Alum	Male Cam Alum	SS Banded	150	150
10600740	4" X 100'	Fem Cam Alum	Male Cam Alum	SS Banded	150	150
10425864	6" x 50'	Fem Cam Alum	Male Cam Alum	SS Banded	115	115
10600741	6" X 100'	Fem Cam Alum	Male Cam Alum	SS Banded	115	115



LGG Part Number	Hose Size	End - 1	End - 2	Attachment Method	Max Hose WP PSI	Max Hose WP PSI
10425764	2" x 50'			SS Banded	150	150
10600742	2" X 100'	Fem NPSH Pin Lug	Male NPSH	SS Banded	150	150
10425738	3" x 50'	Fem NPSH Pin Lug	Male NPSH	SS Banded	150	150
10600743	3" X 100'	Fem NPSH Pin Lug	Male NPSH	SS Banded	150	150
10425759	4" x 50'	Fem NPSH Pin Lug	Male NPSH	SS Banded	150	150
10600744	4" X 100'	Fem NPSH Pin Lug	Male NPSH	SS Banded	150	150



LGG Part Number	Hose Size	End - 1	End - 2	Attachment Method	Max Hose WP PSI	Max Hose WP PSI
10425878	3" x 50'			SS Banded	120	120
10425827	4" x 50'	Bauer Ball	Bauer Socket	SS Banded	120	120
10425767	6" x 50'	Bauer Ball	Bauer Socket	SS Banded	90	90
10600269	8" x 50'	Bauer Ball	Bauer Socket	SS Banded	75	75



NOTE: Maximum WP of assembly is temperature-dependent.

Snap-tite TPX Yellow Nitrile Layflat Discharge Hose

Application: A premium high-pressure layflat hose, built to handle the most rugged industrial environments including: rental, constuction, mining, dewatering, agriculture, marine, refineries, general discharge, irrigation, and chemical. Remains flexible in low temperatures and is resistant to ozone, oxidation, and most chemicals and petrochemicals.



Temperature Range: -20°F to +200°F (-29°C to +93°C)
Tube: Nitrile rubber liner – smooth to keep friction loss to a minimum.

Reinforcement: 3-ply polyester yarn

Cover: Yellow nitrile rubber

Note: Popular assemblies shown below – additional sizes and assemblies are available upon request.

LGG Part Number	Hose Size	End - 1	End - 2	Attachment Method	Max Hose WP PSI	Max Assy WP PSI
10417809	2" x 50'	Fem Cam Alum	Male Cam Alum	SS Branded	400	250
10417798	3" x 50'	Fem Cam Alum	Male Cam Alum	SS Branded	300	150
10417812	4" x 50'	Fem Cam Alum	Male Cam Alum	SS Branded	250	150
10425838	6" x 50'	Fem Cam Alum	Male Cam Alum	SS Branded	200	150

LGG Part Number	Hose Size	End - 1	End - 2	Attachment Method	Max Hose WP PSI	Max Assy WP PSI
10425799	2" x 50'	Fem Cam Alum	Male Cam Alum	Crimped	400	250
10425701	3" x 50'	Fem Cam Alum	Male Cam Alum	Crimped	300	150
10425700	4" x 50'	Fem Cam Alum	Male Cam Alum	Crimped	250	150
10425753	6" x 50'	Fem Cam Alum	Male Cam Alum	Crimped	200	150

LGG Part Number	Hose Size	End - 1	End - 2	Attachment Method	Max Hose WP PSI	Max Assy WP PSI
10425782	2" x 50'	Bauer Ball	Bauer Socket	SS Branded	400	174
10425829	3" x 50'	Bauer Ball	Bauer Socket	SS Branded	300	174
10270334	4" x 50'	Bauer Ball	Bauer Socket	SS Branded	250	174
10305730	6" x 50'	Bauer Ball	Bauer Socket	SS Branded	200	174

LGG Part Number	Hose Size	End - 1	End - 2	Attachment Method	Max Hose WP PSI	Max Assy WP PSI
10425736	2" x 50'	Bauer Ball	Bauer Socket	Crimped	400	174
10425723	3" x 50'	Bauer Ball	Bauer Socket	Crimped	300	174
10425770	4" x 50'	Bauer Ball	Bauer Socket	Crimped	250	174
10425785	6" x 50'	Bauer Ball	Bauer Socket	Crimped	200	174



NOTE: Maximum WP of assembly is temperature-dependent.

Mill Water Discharge Hose

- Application:** Lightweight general purpose hose designed for open-ended discharge applications.
- Tube:** Black synthetic rubber
- Reinforcement:** Woven polyester yarn
- Cover:** White, synthetic woven. Single and double jacket available.
- Safety Note:** Not recommended for use as fire hose.
- Note:** Popular assemblies shown below – additional sizes and assemblies are available upon request.





Single Jacket Mill Hose assemblies

LGG Part Number	Hose Size	End - 1 	End - 2 	Attachment Method	Max Hose WP PSI	Max Assy WP PSI
10019331	1-1/2" x 50'	NPSH - Pin Lug	NPSH - Pin Lug	SS Banded	115	75
10309142	2" X 50'	NPSH - Pin Lug	NPSH - Pin Lug	SS Banded	115	75
10141718	3" x 50'	NPSH - Pin Lug	NPSH - Pin Lug	SS Banded	115	50
10268680	4" x 50'	NPSH - Pin Lug	NPSH - Pin Lug	SS Banded	115	50



LGG Part Number	Hose Size	End - 1 	End - 2 	Attachment Method	Max Hose WP PSI	Max Assy WP PSI
10063549	1-1/2" x 50'	NST - Rocker Lug	NST - Rocker Lug	Swaged	115	115
10038989	2-1/2" x 50'	NST - Rocker Lug	NST - Rocker Lug	Swaged	115	115
10600561	3" x 50'	NST - Rocker Lug	NST - Rocker Lug	Swaged	115	115





LGG Part Number	Hose Size	End - 1 	End - 2 	Attachment Method	Max Hose WP PSI	Max Assy WP PSI
10214245	2" x 50'	Fem Cam Alum	Male Cam Alum	SS Banded	115	115
10600309	2" x 100'	Fem Cam Alum	Male Cam Alum	SS Banded	115	115
10266336	3" x 50'	Fem Cam Alum	Male Cam Alum	SS Banded	115	115
10600310	3" x 100'	Fem Cam Alum	Male Cam Alum	SS Banded	115	115



NOTE: Maximum WP of assembly is temperature-dependent.

Double Jacket Mill Hose Assemblies

LGG Part Number	Hose Size	End - 1 	End - 2 	Attachment Method	Max Hose WP PSI	Max Assy WP PSI
10600311	1-1/2" x 50'	NPSH - Rocker Lug	NPSH - Rocker Lug	Int. Expansion	200	200
10600312	2-1/2" x 50'	NPSH - Rocker Lug	NPSH - Rocker Lug	Int. Expansion	200	200
10600313	1-1/2" x 50'	NST - Rocker Lug	NST - Rocker Lug	Int. Expansion	200	200
10600314	1-1/2" x 100'	NST - Rocker Lug	NST - Rocker Lug	Int. Expansion	200	200
10600315	2-1/2" x 50'	NST - Rocker Lug	NST - Rocker Lug	Int. Expansion	200	200

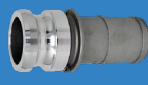

LGG Part Number	Hose Size	End - 1 	End - 2 	Attachment Method	Max Hose WP PSI	Max Assy WP PSI
10600316	2" x 50'	Fem Cam Alum	Male Cam Alum	SS Banded	200	200
10600317	2" x 100'	Fem Cam Alum	Male Cam Alum	SS Banded	200	200
10600318	3" x 50'	Fem Cam Alum	Male Cam Alum	SS Banded	200	125
10600319	4" x 50'	Fem Cam Alum	Male Cam Alum	SS Banded	200	100



NOTE: Maximum WP of assembly is temperature-dependent.



Black or Yellow Nitrile Layflat Discharge Hose

Application: Suitable for irrigation, washdown, and water-discharge applications. This hose is a through-the-weave Nitrile Rubber-covered hose made from 100% synthetic woven yarn.

Temperature Range: -4°F to +176°F (-20°C up to +80°C)

Tube: Very smooth for minimum friction loss

Reinforcement: Circular woven polyester jacket

Cover: Ribbed for more abrasion resistance

Note: Popular assemblies shown below – additional sizes and assemblies are available upon request.



LGG Part Number - Black	LGG Part Number - Yellow	Hose Size	End - 1	End - 2	Attachment Method	Max Hose WP PSI	Max Assy WP PSI
10425719	10600287	2" x 25'	Fem Cam Alum	Male Cam Alum	Crimped	300	300
10422644	10600288	2" x 50'	Fem Cam Alum	Male Cam Alum	Crimped	300	300
10425792	10600289	3" x 25'	Fem Cam Alum	Male Cam Alum	Crimped	250	250
10422654	10600290	3" x 50'	Fem Cam Alum	Male Cam Alum	Crimped	250	250
10425790	10600291	4" x 25'	Fem Cam Alum	Male Cam Alum	Crimped	200	200
10422660	10600292	4" x 50'	Fem Cam Alum	Male Cam Alum	Crimped	200	200
10425725	10600293	6" x 25'	Fem Cam Alum	Male Cam Alum	Crimped	150	150
10422657	10600294	6" x 50'	Fem Cam Alum	Male Cam Alum	Crimped	150	150
10600465*	10600700*	8" X 50'	Fem Cam Alum	Male Cam Alum	Crimped	150	150

*Specify (N)=Type 1 for NECO Style or (P)=Type 2 for PT Style.

LGG Part Number - Black	LGG Part Number - Yellow	Hose Size	End - 1	End - 2	Attachment Method	Max Hose WP PSI	Max Assy WP PSI
10425851	10600295	4" x 25'	Bauer Ball	Bauer Socket	Crimped	200	200
10423440	10600296	4" x 50'	Bauer Ball	Bauer Socket	Crimped	200	200
10425885	10600297	6" x 25'	Bauer Ball	Bauer Socket	Crimped	150	150
10423441	10600298	6" x 50'	Bauer Ball	Bauer Socket	Crimped	150	150
10425777	10600299	8" x 25'	Bauer Ball	Bauer Socket	Crimped	150	150
10423442	10600300	8" x 50'	Bauer Ball	Bauer Socket	Crimped	150	150

LGG Part Number - Black	LGG Part Number - Yellow	Hose Size	End - 1	End - 2	Attachment Method	Max Hose WP PSI	Max Assy WP PSI
10425750	10600301	3" x 25'	Grooved End - CS	Grooved End - CS	Crimped	250	250
10425843	10600302	3" x 50'	Grooved End - CS	Grooved End - CS	Crimped	250	250
10425826	10600303	4" x 25'	Grooved End - CS	Grooved End - CS	Crimped	200	200
10425768	10600304	4" x 50'	Grooved End - CS	Grooved End - CS	Crimped	200	200
10425831	10600305	6" x 25'	Grooved End - CS	Grooved End - CS	Crimped	150	150
10425840	10600306	6" x 50'	Grooved End - CS	Grooved End - CS	Crimped	150	150

NOTE: Maximum WP of assembly is temperature-dependent.

Pin Lug Gaskets & Wrenches



Pin-Lug Gaskets

LGG Part Number	Size
10282186	1-1/2"
10089101	2"
10223101	3"
10318444	4"
10316986	6"



Pin-Lug Spanner Wrench

LGG Part Number	Size
10600556	1-1/2"
10600557	2"
10600558	3"
10600559	4"
10600560	6"



Adjustable Hydrant Wrench

LGG Part Number
10092867



HD Adjustable Hydrant Wrench

LGG Part Number
10101234



Female Pin-Lug X Male

LGG Part Number	Size
10336348	2-1/2" NST X 1-1/2" NST
10298842	2-1/2" NST X 1-1/2" NPT
10065393	2-1/2" NST X 2" NPT
10308644	2-1/2" NST X 3" NPT
10333247	2-1/2" NST X 4" NPT



Double Male Hex Adapter

LGG Part Number	Size
10600332	1-1/2" NPT X 1-1/2" NST
10249778	2" NPT X 1-1/2" NST
10600180	4" NPT X 4-1/2" NST

Fog Nozzles



Polycarbonate Fog Nozzle

LGG Part Number	Thread	Size
10026190	NPSH	1-1/2"
10107550	NST	1-1/2"
10041686	NPSH	2"



Brass Fog Nozzle

LGG Part Number	Thread	Size
10600329	NPSH	1-1/2"
10600330	NST	1-1/2"
10600331	NPSH	2"

Goodall® Endurance Heavy-Duty Rubber Water Discharge Hose

Application: Heavy-duty water discharge hose for use on construction sites and in quarries and other heavy-duty applications. Intended service is for transferring water and in mobile chiller applications.

Temperature Range: -25°F to +180°F (-32°C to +82°C)

Tube: Black Smooth Synthetic Rubber

Reinforcement: High-tensile textile cords

Cover: Black weather and abrasion resistant synthetic rubber



Note: Popular assemblies shown below – additional sizes and assemblies are available upon request.





LGG Part Number	Hose Size	End - 1	End - 2	Attachment Method	Max Hose WP PSI	Max Assy WP PSI
10425748	2" x 20'	Fem Cam Alum	Male Cam Alum	Crimped	150	150
10425812	2" x 25'	Fem Cam Alum	Male Cam Alum	Crimped	150	150
10425830	2" x 50'	Fem Cam Alum	Male Cam Alum	Crimped	150	150
10425875	3" x 20'	Fem Cam Alum	Male Cam Alum	Crimped	150	150
10425758	3" x 25'	Fem Cam Alum	Male Cam Alum	Crimped	150	150
10425888	3" x 50'	Fem Cam Alum	Male Cam Alum	Crimped	150	150
10425713	4" x 20'	Fem Cam Alum	Male Cam Alum	Crimped	150	150
10425873	4" x 25'	Fem Cam Alum	Male Cam Alum	Crimped	150	150
10425791	4" x 50'	Fem Cam Alum	Male Cam Alum	Crimped	150	150
10425887	6" x 20'	Fem Cam Alum	Male Cam Alum	Crimped	75	75
10425866	6" x 25'	Fem Cam Alum	Male Cam Alum	Crimped	75	75
10425762	6" x 50'	Fem Cam Alum	Male Cam Alum	Crimped	75	75
10425835*	8" x 20'	Fem Cam Alum	Male Cam Alum	Crimped	50	50
10425833*	8" x 25'	Fem Cam Alum	Male Cam Alum	Crimped	50	50
10425871*	8" x 50'	Fem Cam Alum	Male Cam Alum	Crimped	50	50

*Specify (N)=Type 1 for NECO Style or (P)=Type 2 for PT Style.

LGG Part Number	Hose Size	End - 1	End - 2	Attachment Method	Max Hose WP PSI	Max Assy WP PSI
10181630	2" x 25'	Fem Cam Brass	Male Cam Brass	Crimped	150	150
10425825	2" x 50'	Fem Cam Brass	Male Cam Brass	Crimped	150	150
10150864	3" x 25'	Fem Cam Brass	Male Cam Brass	Crimped	150	150
10425847	3" x 50'	Fem Cam Brass	Male Cam Brass	Crimped	150	150
10331549	4" x 25'	Fem Cam Brass	Male Cam Brass	Crimped	150	150
10425779	4" x 50'	Fem Cam Brass	Male Cam Brass	Crimped	150	150
10425804	6" x 25'	Fem Cam Brass	Male Cam Brass	Crimped	75	75
10425749	6" x 50'	Fem Cam Brass	Male Cam Brass	Crimped	75	75

LGG Part Number	Hose Size	End - 1	End - 2	Attachment Method	Max Hose WP PSI	Max Assy WP PSI
10600698	2" X 25'			Crimped	150	150
10600699	2" X 50'	Grooved End - CS	Grooved End - CS	Crimped	150	150
10425711	3" x 25'	Grooved End - CS	Grooved End - CS	Crimped	150	150
10425877	3" x 50'	Grooved End - CS	Grooved End - CS	Crimped	150	150
10425708	4" x 25'	Grooved End - CS	Grooved End - CS	Crimped	150	150
10425717	4" x 50'	Grooved End - CS	Grooved End - CS	Crimped	150	150
10425872	6" x 25'	Grooved End - CS	Grooved End - CS	Crimped	75	75
10425868	6" x 50'	Grooved End - CS	Grooved End - CS	Crimped	75	75

LGG Part Number	Hose Size	End - 1	End - 2	Attachment Method	Max Hose WP PSI	Max Assy WP PSI
10425722	3" x 25'			Crimped	150	150
10425849	3" x 50'	Bauer Ball	Bauer Socket	Crimped	150	150
10425839	4" x 25'	Bauer Ball	Bauer Socket	Crimped	150	150
10425755	4" x 50'	Bauer Ball	Bauer Socket	Crimped	150	150
10425730	6" x 25'	Bauer Ball	Bauer Socket	Crimped	150	150
10425783	6" x 50'	Bauer Ball	Bauer Socket	Crimped	150	150
10425784	8" x 25'	Bauer Ball	Bauer Socket	Crimped	150	150
10600307	8" x 50'	Bauer Ball	Bauer Socket	Crimped	150	150
10600308	10" x 25'	Ball - Type A	Socket - Type A	Crimped	100	50
10425867	10" x 50'	Ball - Type A	Socket - Type A	Crimped	100	50

NOTE: Maximum WP of assembly is temperature-dependent.

Green PVC Suction Hose

Application: An economical and flexible suction hose. Designed for use with industrial pumps in rental and construction dewatering applications, trash pump, drain lines, agricultural, and standard duty water suction.

Temperature Range: -4°F to +150°F (-20°C to +66°C)

Tube: Green PVC

Reinforcement: PVC helix

Cover: Green PVC

Note: Popular assemblies shown below – additional sizes and assemblies are available upon request.



LGG Part Number	Hose Size	End - 1	End - 2	Attachment Method	Max Hose WP PSI	Max Assy WP PSI
10221731	2" x 20'	Fem Cam Alum	Male Cam Alum	SS Banded	60	60
10100873	3" x 20'	Fem Cam Alum	Male Cam Alum	SS Banded	60	60
10219029	4" x 20'	Fem Cam Alum	Male Cam Alum	SS Banded	50	50
10417803	6" x 10'	Fem Cam Alum	Male Cam Alum	SS Banded	35	35
10250398	6" x 20'	Fem Cam Alum	Male Cam Alum	SS Banded	35	35

LGG Part Number	Hose Size	End - 1	End - 2	Attachment Method	Max Hose WP PSI	Max Assy WP PSI
10303829	2" x 20'	Fem Cam Alum	Male NPT	SS Banded	60	60
10320949	3" x 20'	Fem Cam Alum	Male NPT	SS Banded	60	60
10036136	4" x 20'	Fem Cam Alum	Male NPT	SS Banded	50	60
10425761	6" x 10'	Fem Cam Alum	Male NPT	SS Banded	35	60
10109047	6" x 20'	Fem Cam Alum	Male NPT	SS Banded	35	60

LGG Part Number	Hose Size	End - 1	End - 2	Attachment Method	Max Hose WP PSI	Max Assy WP PSI
10281522	2" x 20'	Fem NPSH	Male NPSH	SS Banded	60	60
10234212	3" x 20'	Fem NPSH	Male NPSH	SS Banded	60	60
10094280	4" x 20'	Fem NPSH	Male NPSH	SS Banded	50	50











NOTE: Maximum WP of assembly is temperature-dependent.











Green/Black EDPM Suction Hose







Available in Canada Only

- Application:** Heavy-duty liquid suction hose for use in construction dewatering, liquid waste, cesspool cleaning, septic handling, agricultural applications and marine use.
- Temperature Range:** -40°F to +140°F (-40°C to +60°C)
- Tube:** Smooth EDPM Rubber
- Reinforcement:** Green PVC helix
- Cover:** Corrugated
- Note:** Popular assemblies shown below – additional sizes and assemblies are available upon request.



LGG Part Number	Hose Size	End - 1	End - 2	Attachment Method	Max Hose WP PSI	Max Assy WP PSI
10600761	2" x 20'			SS Banded	50	50
10600762	3" x 20'			SS Banded	43	43
10600763	4" x 20'			SS Banded	38	38
10600764	6" x 10'			SS Banded	23	23
10600765	6" x 20'			SS Banded	23	23

LGG Part Number	Hose Size	End - 1	End - 2	Attachment Method	Max Hose WP PSI	Max Assy WP PSI
10600766	2" x 20'			SS Banded	50	50
10600767	3" x 20'			SS Banded	43	43
10600768	4" x 20'			SS Banded	38	38
10600769	6" x 10'			SS Banded	23	23
10600770	6" x 20'			SS Banded	23	23

LGG Part Number	Hose Size	End - 1	End - 2	Attachment Method	Max Hose WP PSI	Max Assy WP PSI
10600771	2" x 20'			SS Banded	50	50
10600772	3" x 20'			SS Banded	43	43
10600773	4" x 20'			SS Banded	38	38

NOTE: Maximum WP of assembly is temperature-dependent.

Orange Braided Clear PVC Suction Hose

Application: Heavy-duty PVC suction and discharge hose reinforced by a braided polyester yarn helix. Offers a high vacuum and pressure rating while maintaining flexibility. Lightweight, flexible, and easy to handle. Transparent for easy inspection. Cold, weather resistance with high chemical tolerance. For use in rental, construction, and general service for heavy-duty suction and drainage.

Temperature Range: 2"-8" ID: -40°F to +150°F (-40°C to +65°C) 10"-12" ID: -13°F to +140°F (-25°C to +60°C)

Tube: PVC

Reinforcement: Braided polyester yarn, orange PVC clockwise helix

Note: Popular assemblies shown below – additional sizes and assemblies are available upon request.



LGG Part Number	Hose Size	End - 1	End - 2	Attachment Method	Max Hose WP PSI	Max Assy WP PSI
10425869	2" x 20'	Fem Cam Alum	Male Cam Alum	Crimped	110	110
10425801	3" x 20'	Fem Cam Alum	Male Cam Alum	Crimped	100	100
10425848	4" x 20'	Fem Cam Alum	Male Cam Alum	Crimped	110	110
10425796	6" x 10'	Fem Cam Alum	Male Cam Alum	Crimped	90	90
10425735	6" x 20'	Fem Cam Alum	Male Cam Alum	Crimped	90	90
10425897*	8" x 10'	Fem Cam Alum	Male Cam Alum	Crimped	85	85
10425741*	8" x 20'	Fem Cam Alum	Male Cam Alum	Crimped	85	85

*Specify (N)=Type 1 for NECO Style or (P)=Type 2 for PT Style.

LGG Part Number	Hose Size	End - 1	End - 2	Attachment Method	Max Hose WP PSI	Max Assy WP PSI
10425710	4" x 20'	Bauer Ball	Bauer Socket	Crimped	110	110
10425714	6" x 10'	Bauer Ball	Bauer Socket	Crimped	90	90
10425789	6" x 20'	Bauer Ball	Bauer Socket	Crimped	90	90
10425757	8" x 10'	Bauer Ball	Bauer Socket	Crimped	85	85
10425702	8" x 20'	Bauer Ball	Bauer Socket	Crimped	85	85
10425842	10" x 10'	Ball - Type A	Socket - Type A	Crimped	40	40
10196012	10" x 20'	Ball - Type A	Socket - Type A	Crimped	40	40
10077936	12" x 10'	Ball - Type A	Socket - Type A	Crimped	28	28
10425787	12" x 20'	Ball - Type A	Socket - Type A	Crimped	28	28

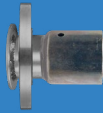
LGG Part Number	Hose Size	End - 1 	End - 2 	Attachment Method	Max Hose WP PSI	Max Assy WP PSI
10425744	4" x 10'	150# Fixed Flange	150# Floating Flange	Crimped	110	110
10425794	4" x 20'	150# Fixed Flange	150# Floating Flange	Crimped	110	110
10425763	6" x 10'	150# Fixed Flange	150# Floating Flange	Crimped	90	90
10425895	6" x 20'	150# Fixed Flange	150# Floating Flange	Crimped	90	90
10425718	8" x 10'	150# Fixed Flange	150# Floating Flange	Crimped	85	85
10425721	8" x 20'	150# Fixed Flange	150# Floating Flange	Crimped	85	85
10425720	10" x 10'	150# Fixed Flange	150# Floating Flange	Crimped	40	40
10425837	10" x 20'	150# Fixed Flange	150# Floating Flange	Crimped	40	40
10425815	12" x 10'	150# Fixed Flange	150# Floating Flange	Crimped	28	28
10425896	12" x 20'	150# Fixed Flange	150# Floating Flange	Crimped	28	28

NOTE: Maximum WP of assembly is temperature-dependent.



Goodall® Alligator SD Flexoline Rubber Water Suction/Discharge Hose

Application: Heavy-duty rubber suction and discharge hose, resistant to aqueous solutions of mild chemicals and fertilizers in general industrial and agricultural applications. For construction, quarries, mining, dewatering, heavy-duty application, and general use.

Temperature Range: -22°F to +212°F (-30°C to +100°C)







Tube: Black Smooth Synthetic Rubber

Reinforcement: High-tensile, spiral-ply textile cords and steel wire helix



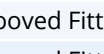
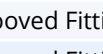
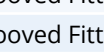
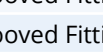
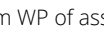
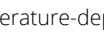

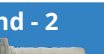

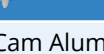

Cover: Black weather and abrasion resistant synthetic rubber

Note: Popular assemblies shown below - additional sizes and assemblies are available upon request

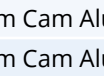
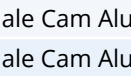
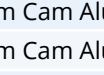
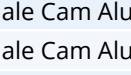
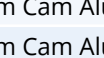

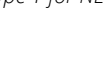
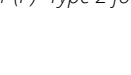

LGG Part Number	Hose Size	End - 1	End - 2	Attachment Method	Max Hose WP PSI	Max Assy WP PSI
10600323	3" x 10'			Crimped	150	150
10600324	3" x 20'			Crimped	150	150
10600325	4" x 10'			Crimped	150	150
10600326	4" x 20'			Crimped	150	150
10600327	6" x 10'			Crimped	150	150
10600328	6" x 20'			Crimped	150	150



NOTE: Maximum WP of assembly is temperature-dependent.



LGG Part Number	Hose Size	End - 1	End - 2	Attachment Method	Max Hose WP PSI	Max Assy WP PSI
10600209	2" X 10'			Crimped	150	150
10046494	2" x 20'			Crimped	150	150
10293010	3" x 20'			Crimped	150	150
10600320	4" x 10'			Crimped	150	150
10262240	4" x 20'			Crimped	150	150
10425739	6" x 10'			Crimped	150	75
10425724	6" x 20'			Crimped	150	75
10600321*	8" x 10'			Crimped	150	45
10600322*	8" x 20'			Crimped	150	45

Brass fittings available upon request

**Specify (N)=Type 1 for NECO Style or (P)=Type 2 for PT Style.*

LGG Part Number	Hose Size	End - 1	End - 2	Attachment Method	Max Hose WP PSI	Max Assy WP PSI
10600601	4" X 10'			Crimped	150	150
10425716	4" x 20'	Bauer Ball	Bauer Socket	Crimped	150	150
10425820	6" x 10'	Bauer Ball	Bauer Socket	Crimped	150	150
10425832	6" x 20'	Bauer Ball	Bauer Socket	Crimped	150	150
10425769	8" x 10'	Bauer Ball	Bauer Socket	Crimped	150	150
10425800	8" x 20'	Bauer Ball	Bauer Socket	Crimped	150	150

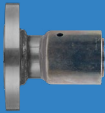
LGG Part Number	Hose Size	End - 1	End - 2	Attachment Method	Max Hose WP PSI	Max Assy WP PSI
10600696	10" X 10'			Crimped	75	75
10600697	10" X 20'	Ball - Type A	Socket - Type A	Crimped	75	75
10600659	12" X 10'	Ball - Type A	Socket - Type A	Crimped	75	75
10600490	12" X 20'	Ball - Type A	Socket - Type A	Crimped	75	75

LGG Part Number	Hose Size	End - 1	End - 2	Attachment Method	Max Hose WP PSI	Max Assy WP PSI
10600673	3" X 10'			Crimped	150	150
10600674	3" X 20'	150# Fixed Flange	150# Floating Flange	Crimped	150	150
10425858	4" x 10'	150# Fixed Flange	150# Floating Flange	Crimped	150	150
10425760	4" x 20'	150# Fixed Flange	150# Floating Flange	Crimped	150	150
10425726	6" x 10'	150# Fixed Flange	150# Floating Flange	Crimped	150	150
10425857	6" x 20'	150# Fixed Flange	150# Floating Flange	Crimped	150	150
10425709	8" x 10'	150# Fixed Flange	150# Floating Flange	Crimped	150	150
10425699	8" x 20'	150# Fixed Flange	150# Floating Flange	Crimped	150	150





NOTE: Maximum WP of assembly is temperature-dependent.







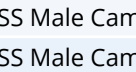

UHMW Corrugated Chemical Suction Discharge Hose



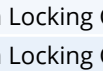
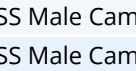

- Application:** UHMWPE tube chemical handles the majority of common industrial chemicals in pressure, gravity flow and suction service.
- Temperature Range:** -40°F to +220°F (-40°C to +100°C)
- Tube:** Smooth ultra-high molecular weight polyethylene (UHMWPE)
- Reinforcement:** Spiral-plied synthetic fabric with double wire helix
- Cover:** Corrugated green EPDM
- Note:** Popular assemblies shown below – additional sizes and assemblies are available upon request.

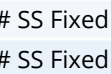
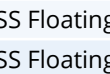
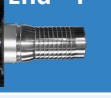
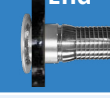

LGG Part Number	Hose Size	End - 1	End - 2	Attachment Method	Max Hose WP PSI	Max Assy WP PSI
10425890	2" x 20'			Crimped	150	150
10425697	3" x 20'			Crimped	150	125
10425845	4" x 20'			Crimped	150	125

LGG Part Number	Hose Size	End - 1	End - 2	Attachment Method	Max Hose WP PSI	Max Assy WP PSI
10425876	2" x 20'			Crimped	150	150
10425818	3" x 20'			Crimped	150	150
10425865	4" x 20'			Crimped	150	150

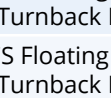
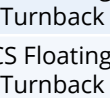
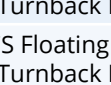
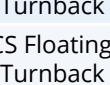
LGG Part Number	Hose Size	End - 1	End - 2	Attachment Method	Max Hose WP PSI	Max Assy WP PSI
10425778	2" x 20'			Crimped	150	150
10425698	3" x 20'			Crimped	150	150
10425846	4" x 20'			Crimped	150	150

LGG Part Number	Hose Size	End - 1	End - 2	Attachment Method	Max Hose WP PSI	Max Assy WP PSI
10600600	2" X 20'			Crimped	150	150
10600444	3" x 20'			Crimped	150	150
10600448	4" x 20'			Crimped	150	150
10600445	6" x 20'			Crimped	150	150





NOTE: Maximum WP of assembly is temperature-dependent.





Goodall® Kemflex Chemical Hose

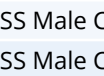

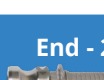

Available in Canada Only

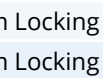
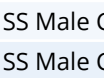
- Application:** UHMWPE tube chemical hose for use in most chemical applications. Superior braided construction is flexible and resistant to kinking. Can be open-end steam-cleaned (max. 30 minutes at 266°F/130°C). Formulated EDPM cover with excellent abrasion resistance.
- Temperature Range:** -40°F to +212°F (-40°C to +100°C)
- Tube:** Clear ultra-high molecular weight polyethylene (UHMWPE)
- Reinforcement:** Multiple high-tensile textile braids with dual steel wire helix
- Cover:** Green weather, ozone, and abrasion resistant EDPM
- Note:** Popular assemblies shown below – additional sizes and assemblies are available upon request.

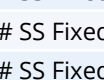
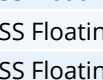
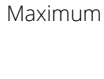

LGG Part Number	Hose Size	End - 1	End - 2	Attachment Method	Max Hose WP PSI	Max Assy WP PSI
10425890-CRN	2" x 20'			Crimped	250	250
10425697-CRN	3" x 20'			Crimped	200	200
10425845-CRN	4" x 20'			Crimped	200	200

LGG Part Number	Hose Size	End - 1	End - 2	Attachment Method	Max Hose WP PSI	Max Assy WP PSI
10425876-CRN	2" x 20'			Crimped	250	250
10425818-CRN	3" x 20'			Crimped	200	200
10425865-CRN	4" x 20'			Crimped	200	200

LGG Part Number	Hose Size	End - 1	End - 2	Attachment Method	Max Hose WP PSI	Max Assy WP PSI
10425778-CRN	2" x 20'			Crimped	250	250
10425698-CRN	3" x 20'			Crimped	200	200
10425846-CRN	4" x 20'			Crimped	200	200

NOTE: Maximum WP of assembly is temperature-dependent.

Water Pump Composite Hose

Application: Specifically designed for the rental industry. Suction and discharge hose provides extreme flexibility, lightweight handling, and excellent service life. Excellent for the transfer of water, dirty oily water, and light chemicals. Used in a wide variety of pump applications.



Temperature Range: -40°F to +212°F (-40°C to +100°C)
 Not suggested for use in ship-to-shore applications, marine dock, crude oil, bunker oil, or heavy viscous product applications. Consult LGG Industrial for chemical resistance chart.

Note: Popular assemblies shown below – additional sizes and assemblies are available upon request.

LGG Part Number	LGG CRN Part Number	Hose Size	End - 1	End - 2	Attachment Method	Max Hose WP PSI	Max Assy WP PSI
10422645	10422645-CRN	4" x 10'	150# Fixed Flange	150# Floating Flange	Crimped	230	230
10422646	10422646-CRN	4" x 20'	150# Fixed Flange	150# Floating Flange	Crimped	230	230
10422653	10422653-CRN	6" x 10'	150# Fixed Flange	150# Floating Flange	Crimped	230	230
10055562	10055562-CRN	6" x 20'	150# Fixed Flange	150# Floating Flange	Crimped	230	230
10422667	10422667-CRN	8" x 10'	150# Fixed Flange	150# Floating Flange	Crimped	230	230
10422648	10422648-CRN	8" x 20'	150# Fixed Flange	150# Floating Flange	Crimped	230	230
10425704	10425704 -CRN	10" x 10'	150# Fixed Flange	150# Floating Flange	Crimped	230	230
10193897	10193897-CRN	10" x 20'	150# Fixed Flange	150# Floating Flange	Crimped	230	230
10600265	10600265-CRN	12" x 10'	150# Fixed Flange	150# Floating Flange	Crimped	230	230
10600266	10600266-CRN	12" x 20'	150# Fixed Flange	150# Floating Flange	Crimped	230	230

NOTE: Maximum WP of assembly is temperature-dependent.



Oil Pump Composite Hose

Application: Heavy Duty construction for the transfer of a wide variety of hydrocarbon conveyant under suction or pressure. Used for black oils and heavier lubricating products, Ship to Shore and Ship to Ship, Dockside and in general for the most arduous Industrial and Marine applications. Commonly used for all hose loading arms in Bottom Loading operations, thanks to the special reinforcement for minimal elongation. Fully suitable for 100% aromatics & MTBE transfer



Temperature Range: -40°F to +212°F (-40°C to +100°C)

End Fittings: Specially designed end fittings have a unique leak-proof sealing face and specially machined helical spiral shank which engages into the corresponding internal helix wire when secured into the hose by either crimping or swaging the external ferrules.

Note: Popular assemblies shown below – additional sizes and assemblies are available upon request.

LGG Part Number	LGG CRN Part Number	Hose Size	End - 1	End - 2	Attachment Method	Max Hose WP PSI	Max Assy WP PSI
10248975	10248975-CRN	4" x 10'	150# Fixed Flange	150# Floating Flange	Crimped	250	250
10188234	10188234-CRN	4" x 20'	150# Fixed Flange	150# Floating Flange	Crimped	230	230
10254751	10254751-CRN	6" x 10'	150# Fixed Flange	150# Floating Flange	Crimped	230	230
10032414	10032414-CRN	6" x 20'	150# Fixed Flange	150# Floating Flange	Crimped	230	230
10425859	10425859-CRN	8" x 10'	150# Fixed Flange	150# Floating Flange	Crimped	250	250
10025441	10025441-CRN	8" x 20'	150# Fixed Flange	150# Floating Flange	Crimped	250	250
10425886	10425886-CRN	10" x 10'	150# Fixed Flange	150# Floating Flange	Crimped	200	200
10425809	10425809-CRN	10" x 20'	150# Fixed Flange	150# Floating Flange	Crimped	200	200

NOTE: Maximum WP of assembly is temperature-dependent.

Petroleum Tank Truck Hose (Red Stripe)

Application: For transfer of oils, crude, and fuels with aromatics content to 50%. Robust construction that is kink-resistant but still flexible.

Temperature Range: -40°F to +180°F (-40°C to +82°C)

Tube: Black smooth nitrile (NBR) compound, exceptional resistance to oil

Reinforcement: Multiple fabric plies, steel helical wire

Cover: Black weather, ozone, oil, and abrasion resistant synthetic rubber. 2" and 3" smooth cover. 4", 6", and 8" corrugated cover.

Note: Popular assemblies shown below – additional sizes and assemblies are available upon request.





LGG Part Number	Hose Size	End - 1	End - 2	Attachment Method	Max Hose WP PSI	Max Assy WP PSI
10425805	2" x 20'	Fem Cam Alum	Male Cam Alum	Crimped	150	150
10425765	3" x 20'	Fem Cam Alum	Male Cam Alum	Crimped	150	150
10600662	4" X 10'	Fem Cam Alum	Male Can Alum	Crimped	150	150
10425795	4" x 20'	Fem Cam Alum	Male Cam Alum	Crimped	150	150
10425788	6" x 10'	Fem Cam Alum	Male Cam Alum	Crimped	150	150
10425786	6" x 20'	Fem Cam Alum	Male Cam Alum	Crimped	150	150
10600334*	8" x 20'	Fem Cam Alum	Male Cam Alum	Crimped	150	150

*Specify (N)=Type 1 for NECO Style or (P)=Type 2 for PT Style.

LGG Part Number	Hose Size	End - 1	End - 2	Attachment Method	Max Hose WP PSI	Max Assy WP PSI
10600333	2" x 20'	150# Fixed Flange	150# Floating Flange	Crimped	150	150
10425841	3" x 10'	150# Fixed Flange	150# Floating Flange	Crimped	150	150
10425756	3" x 20'	150# Fixed Flange	150# Floating Flange	Crimped	150	150
10425810	4" x 10'	150# Fixed Flange	150# Floating Flange	Crimped	150	150
10425853	4" x 20'	150# Fixed Flange	150# Floating Flange	Crimped	150	150
10425737	6" x 10'	150# Fixed Flange	150# Floating Flange	Crimped	150	150
10425807	6" x 20'	150# Fixed Flange	150# Floating Flange	Crimped	150	150
10600693	8" X 10'	150# Fixed Flange	150# Floating Flange	Crimped	150	150
10600668	8" X 20'	150# Fixed Flange	150# Floating Flange	Crimped	150	150

NOTE: Maximum WP of assembly is temperature-dependent.

LGG Part Number	Hose Size	End - 1	End - 2	Attachment Method	Max Hose WP PSI	Max Assy WP PSI
10425821	4" x 10'	 Bauer Ball	 Bauer Socket	Crimped	150	150
10425874	4" x 20'	Bauer Ball	Bauer Socket	Crimped	150	150
10425806	6" x 10'	Bauer Ball	Bauer Socket	Crimped	150	150
10425798	6" x 20'	Bauer Ball	Bauer Socket	Crimped	150	150
10600694	8" X 10'	Bauer Ball	Bauer Socket	Crimped	150	150
10600695	8" X 20'	Bauer Ball	Bauer Socket	Crimped	150	150

NOTE: Maximum WP of assembly is temperature-dependent.

Oil S&D Hose With Built-in Flanges

Application: This smooth-bore dock hose is manufactured with built-in carbon steel 150# ANSI flanges. Meets USCG certification requirements per USCG 33CFR 154.500. Heavy-duty suction discharge hose for use in oil, petroleum, and water.

Temperature Range: -40°F to +190°F (-40°C to +88°C)

Tube: Black nitrile (NBR), 55% aromatics (ORS)

Reinforcement: High-tensile cord plies, helix wire

Cover: Black neoprene

Note: Popular assemblies shown below – additional sizes and assemblies are available upon request.

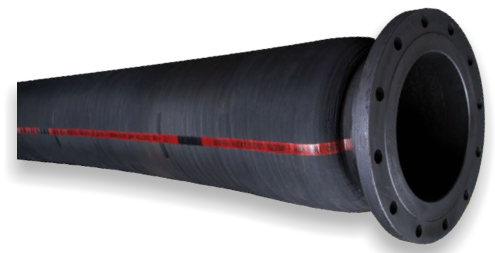

LGG Part Number	LGG CRN Part Number	Hose Size	End - 1	End - 2	Attachment Method	Max Hose WP PSI	Max Assy WP PSI
10425814	10425814-CRN	4" x 10'	150# Fixed Flange	150# Floating Flange	Built-In	250	250
10425771	10425771-CRN	4" x 20'	150# Fixed Flange	150# Floating Flange	Built-In	250	250
10425817	10425817-CRN	6" x 10'	150# Fixed Flange	150# Floating Flange	Built-In	250	250
10425745	10425745-CRN	6" x 20'	150# Fixed Flange	150# Floating Flange	Built-In	250	250
10425834	10425834-CRN	8" x 10'	150# Fixed Flange	150# Floating Flange	Built-In	250	250
10425816	10425816-CRN	8" x 20'	150# Fixed Flange	150# Floating Flange	Built-In	250	250
10425696	10425696-CRN	10" x 10'	150# Fixed Flange	150# Floating Flange	Built-In	250	250
10425862	10425862-CRN	10" x 20'	150# Fixed Flange	150# Floating Flange	Built-In	250	250
10425882	10425882-CRN	12" x 10'	150# Fixed Flange	150# Floating Flange	Built-In	250	250
10425751	10425751-CRN	12" x 20'	150# Fixed Flange	150# Floating Flange	Built-In	250	250

NOTE: Maximum WP of assembly is temperature-dependent.

Stainless Steel Metal Hose

Application: High-performance hose assembly suitable for use in petroleum, chemical, steel, and power generation applications. These hose assemblies can be used in heating, pump, ventilation, and air conditioning systems among others.

Construction: Annular corrugated stainless steel construction with ANSI 150# floating x floating flanges



Material: 321 stainless steel inner corrugated tube, 304 stainless steel double braided exterior, 316 stainless steel stub end

Characteristics: Lightweight and flexible

Note: Popular assemblies shown below – additional sizes and assemblies are available upon request, including 300# flanges.

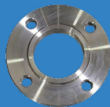
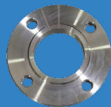

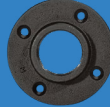
LGG US Part Number	LGG Canada Part Number	Hose Size	 End - 1 304 STAINLESS STEEL	 End - 2 304 STAINLESS STEEL	Max Hose WP PSI	Max Assy WP PSI
10422647	10422647-CRN	1" x 20'	150# Floating Flange; 304 SS	150# Floating Flange; 304 SS	1077	285
10422659	10422659-CRN	2" x 20'	150# Floating Flange; 304 SS	150# Floating Flange; 304 SS	812	285
10422651	10422651-CRN	3" x 20'	150# Floating Flange; 304 SS	150# Floating Flange; 304 SS	464	285
10600272	10600272-CRN	4" x 10'	150# Floating Flange; 304 SS	150# Floating Flange; 304 SS	418	285
10422661	10422661-CRN	4" x 20'	150# Floating Flange; 304 SS	150# Floating Flange; 304 SS	418	285
10600273	10600273-CRN	6" x 10'	150# Floating Flange; 304 SS	150# Floating Flange; 304 SS	290	272
10422669	10422669-CRN	6" x 20'	150# Floating Flange; 304 SS	150# Floating Flange; 304 SS	290	272
10600486	10600486-CRN	8" x 10'	150# Floating Flange; 304 SS	150# Floating Flange; 304 SS	360	285
10422666	10422666-CRN	8" x 20'	150# Floating Flange; 304 SS	150# Floating Flange; 304 SS	232	232
10600471	10600471-CRN	10" x 10'	150# Floating Flange; 304 SS	150# Floating Flange; 304 SS	310	285
10600530	10600530-CRN	10" x 20'	150# Floating Flange; 304 SS	150# Floating Flange; 304 SS	310	285
10600535	10600535-CRN	12" x 10'	150# Floating Flange; 304 SS	150# Floating Flange; 304 SS	325	285
10600274	10600274-CRN	12" x 20'	150# Floating Flange; 304 SS	150# Floating Flange; 304 SS	139	139

LGG US Part Number	LGG Canada Part Number	Hose Size	 End - 1 CARBON STEEL	 End - 2 CARBON STEEL	Max Hose WP PSI	Max Assy WP PSI
10422665	10422665-CRN	1" x 20'	150# Floating Flange; CS	150# Floating Flange; CS	1077	285
10422650	10422650-CRN	2" x 20'	150# Floating Flange; CS	150# Floating Flange; CS	812	285
10422652	10422652-CRN	3" x 20'	150# Floating Flange; CS	150# Floating Flange; CS	464	285
10600532	10600532-CRN	4" x 10'	150# Floating Flange; CS	150# Floating Flange; CS	448	285
10422656	10422656-CRN	4" x 20'	150# Floating Flange; CS	150# Floating Flange; CS	418	285
10600493	10600493-CRN	6" x 10'	150# Floating Flange; CS	150# Floating Flange; CS	315	285
10422664	10422664-CRN	6" x 20'	150# Floating Flange; CS	150# Floating Flange; CS	290	272
10600504	10600504-CRN	8" x 10'	150# Floating Flange; CS	150# Floating Flange; CS	360	285
10422668	10422668-CRN	8" x 20'	150# Floating Flange; CS	150# Floating Flange; CS	232	232
10600534	10600534-CRN	10" x 10'	150# Floating Flange; CS	150# Floating Flange; CS	310	285
10600531	10600531-CRN	10" x 20'	150# Floating Flange; CS	150# Floating Flange; CS	310	285
10600533	10600533-CRN	12" x 10'	150# Floating Flange; CS	150# Floating Flange; CS	325	285
10600525	10600525-CRN	12" x 20'	150# Floating Flange; CS	150# Floating Flange; CS	325	285

NOTE: Maximum WP of assembly is temperature-dependent.

Camlock Fittings



Aluminum Part A

LGG Part Number	Size
10417816	1/2"
10300358	3/4"
10254214	1"
10312501	1-1/4"
10298506	1-1/2"
10327269	2"
10276547	2-1/2"
10332699	3"
10139469	4"
10236138	5"
10251685	6"



Aluminum Part B

LGG Part Number	Size
10417813	1/2"
10303609	3/4"
10321348	1"
10025809	1-1/4"
10292321	1-1/2"
10218473	2"
10244885	2-1/2"
10104164	3"
10236839	4"
10059995	5"
10198580	6"



Aluminum Part C

LGG Part Number	Size
10103932	1/2"
10298797	3/4"
10293330	1"
10306917	1-1/4"
10115791	1-1/2"
10295741	2"
10144427	2-1/2"
10301139	3"
10157871	4"
10024635	5"
10332869	6"



Aluminum Part D

LGG Part Number	Size
10417810	1/2"
10311496	3/4"
10207640	1"
10219608	1-1/4"
10208206	1-1/2"
10270046	2"
10252175	2-1/2"
10311934	3"
10250892	4"
10094026	5"
10218576	6"



Aluminum Part E

LGG Part Number	Size
10417802	1/2"
10254263	3/4"
10322700	1"
10134024	1-1/4"
10310190	1-1/2"
10307554	2"
10286393	2-1/2"
10208855	3"
10287422	4"
10088268	5"
10317277	6"



Aluminum Part F

LGG Part Number	Size
10165549	1/2"
10114881	3/4"
10212117	1"
10325358	1-1/4"
10331445	1-1/2"
10241844	2"
10324710	2-1/2"
10277796	3"
10330175	4"
10119271	5"
10276208	6"



Aluminum Part DC

LGG Part Number	Size
10425802	1/2"
10193076	3/4"
10315963	1"
10113784	1-1/4"
10046309	1-1/2"
10279310	2"
10046989	2-1/2"
10189709	3"
10312293	4"
10168658	5"
10287987	6"



Aluminum Part DP

LGG Part Number	Size
10200828	1/2"
10155864	3/4"
10333768	1"
10177230	1-1/4"
10324817	1-1/2"
10254239	2"
10142359	2-1/2"
10170375	3"
10331963	4"
10295755	5"
10192521	6"

Camlock Accessories



Gaskets

LGG Part Number		Size
Petroleum Buna-N	Chemical FMK	
10350867	10271850	1/2"
10069455	10136199	3/4"
10319730	10147101	1"
10088351	10132704	1-1/4"
10317288	10036204	1-1/2"
10115466	10163688	2"
10194127	10255844	2-1/2"
10271698	10110660	3"
10209309	10249279	4"
10417815	10166950	5"
10143480	10403265	6"



Replacement Arms

LGG Part Number	Size
10343428	1/2" & 3/4"
10090728	1"
10130608	1-1/2" & 2"
10035994	3" - 5"
10156492	6"



Cam Safety Strap

LGG Part Number	Coupling Sizes
10600552	1" to 1-1/2"
10600553	2" to 3"
10600554	4" to 5"
10600555	6" to 8"



Male x 150# Flange

LGG Part Number	Size
10600536	3"
10600543	4"
10600549	6"
10600541	8"



Female x 150# Flange

LGG Part Number	Size
10600546	3"
10600539	4"
10600544	6"
10600550	8"



Type AA Spool Adapter

LGG Part Number	Size
10600548	2"
10600537	3"
10600540	4"
10600551	6"



Type DD Coupler

LGG Part Number	Size
10600545	2"
10600547	3"
10600538	4"
10600542	6"

Universal Fittings - 2-Lug



Hose End

LGG Part Number	Size
10051343	3/8"
10035128	1/2"
10173990	3/4"
10041638	1"



Male NPT

LGG Part Number	Size
10238388	3/8"
10299261	1/2"
10194437	3/4"
10137466	1"



Female NPT

LGG Part Number	Size
10282428	3/8"
10174501	1/2"
10020289	3/4"
10125568	1"



Gasket

LGG Part Number
10214503



Blank

LGG Part Number
10214143



Safety Pin - Pkg of 25

LGG Part Number
10229528



Triple Connector

LGG Part Number
10277107

Universal Fittings - 4-Lug



Hose End

LGG Part Number	Size
10425775	1-1/4"
10205838	1-1/2"
10223256	2"



Female NPT

LGG Part Number	Size
10054317	1-1/4"
10138963	1-1/2"
10255334	2"



Gasket

LGG Part Number
10109497

Ground Joint Fittings



Ground Joint Stem

LGG Part Number	Size
10382421	1/2"
10296473	3/4"
10091728	1"
10182270	1-1/4"
10228448	1-1/2"
10292093	2"
10039029	2-1/2"
10179535	3"
10181832	4"



Wing Nut

LGG Part Number	Size
10106667	1/2"
10190483	3/4" & 1"
10207780	1-1/4" & 1-1/2"
10112887	2"
10332383	2-1/2"
10064497	3"
10271538	4"



Female Spud

LGG Part Number	Size
10048892	1/2"
10027212	3/4"
10065772	1"
10292209	1-1/4"
10291700	1/1/2"
10287263	2"
10251300	2-1/2"
10155400	3"
10237497	4"



Male Spud

LGG Part Number	Size
10382446	1/2"
10269813	3/4"
10093464	1"
10298653	1-1/4"
10230758	1-1/2"
10083117	2"
10144417	2-1/2"
10250311	3"



Double Spud

LGG Part Number	Size
10284975	1/2"
10278988	3/4" & 1"
10148757	1-1/4" & 1-1/2"
10104229	2"
10348224	2-1/2"
10229033	3"



Male Stem

LGG Part Number	Size
10138052	1/2"
10302447	3/4"
10090775	1"
10144173	1-1/4"
10123507	1/1/2"
10239244	2"
10090307	2-1/2"
10058727	3"
10224689	4"

Whip Checks

LGG Part Number	Hose-to-Tool	
10281635	1/8" cable for 1/2" to 1-1/4" hose-to-tool	
10332325	1/4" cable for 1-1/2" to 3" hose-to-tool	

LGG Part Number	Hose-to-Hose	
10010236	1/8" cable for 1/2" to 1-1/4" hose-to-hose	
10210358	1/4" cable for 1-1/2" to 3" hose-to-hose	

Correct Installation



Incorrect Installation

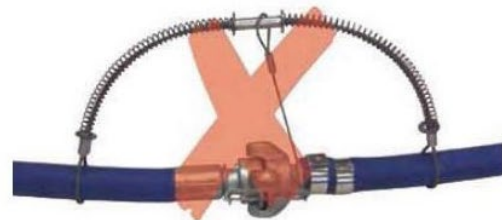

Bauer Fittings

Note: All female couplings include rubber O-ring. All male couplings include lever ring.

Type B



Female Socket X Male Pipe Thread	
LGG Part Number	Size
10600255	4"
10600256	6"
10600257	8"



Male Ball X Male Pipe Thread	
LGG Part Number	Size
10600622	2"
10600252	4"
10600253	6"
10600254	8"



Female Socket X 150# ASA Flange	
LGG Part Number	Size
10600249	4"
10600250	6"
10600251	8"
10600633	12"



Male Ball X 150# ASA Flange	
LGG Part Number	Size
10600247	4"
10600602	6"
10600248	8"
10600635	12"



Reducers	
LGG Part Number	Size
10600631	6" x 4"
10600258	8" x 6"



Increasesers	
LGG Part Number	Size
10600259	4" x 6"
10600260	6" x 8"



Double Male Ball Wye	
LGG Part Number	Size
10600244	6"
10600245	8"



Double Female Socket Wye	
LGG Part Number	Size
10600246	6"



Female Socket X Male Ball Elbow 45°	
LGG Part Number	Size
10600636	2"
10600637	3"
10600237	4"
10600238	6"
10600239	8"
10600638	10"
10600639	12"



Female Socket X Male Ball Elbow 90°	
LGG Part Number	Size
10600640	2"
10600641	3"
10600234	4"
10600235	6"
10600236	8"
10600642	10"
10600643	12"



Female X Male X Female Tee	
LGG Part Number	Size
10600240	4"
10600728	6"
10600241	8"



SBR Sealing Ring	
LGG Part Number	Size
10600648	2"
10600729	3"
10600649	4"
10600650	6"
10600651	8"
10600652	10"
10600653	12"

Note: All female couplings include rubber O-ring. All male couplings include lever ring.

Type B



Male Ball X Round Hole Strainer

LGG Part Number	Size
10600757	10"
10600647	12"



Male Ball X Round Hole Strainer - Long

LGG Part Number	Size
10600242	4"
10600675	6"
10600243	8"

Type A



Female Socket X 150# ASA Flange Type A

LGG Part Number	Size
10600632	10"
10600758	12"



Male Ball X 150# ASA Flange Type A

LGG Part Number	Size
10600634	10"
10600759	12"



Male Ball X Round Hole Strainer Type A

LGG Part Number	Size
10600645	10"
10600646	12"



Fem. Socket X Round Hole Strainer Type A

LGG Part Number	Size
10600644	10"
10600760	12"

Type A →

10" and 12" Sizes

Type B →

2" to 12" Sizes

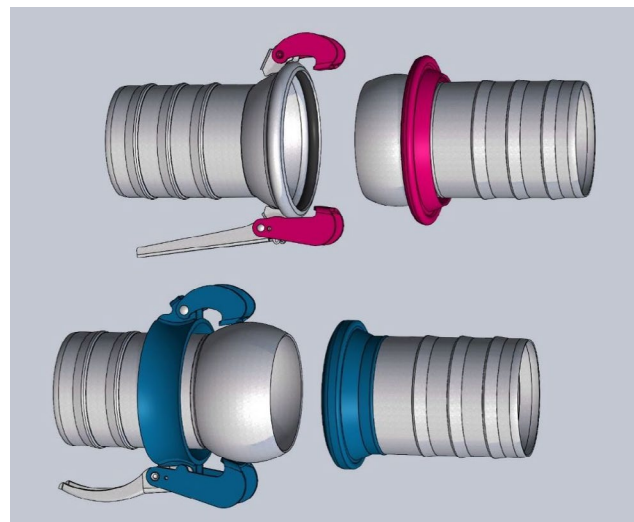

Piping Systems



HPDE Pipe and Tails



Made from SDR 17 High Density Polyethylene Pipe
Available in 4", 6", 8", 10", and 12" sizes
Standard lengths come in 10 and 20 foot long
Male x Female Bauer type end fittings

Tails to be fused to pipe in the field
Male and Female can be purchased separately or in a set
Male Lever purchased seperately for 10" and 12"



Galvanized Steel Pipe

Available in 4", 6", 8", 10", and 12" sizes
Standard lengths come in 3, 6, 10, and 20 foot long
Male x Female Bauer type end fittings
All sizes available with Type B fittings. 10" and 12" also available with Type A fittings
Can be used for suction or pressure applications



Stackable Storage Racks

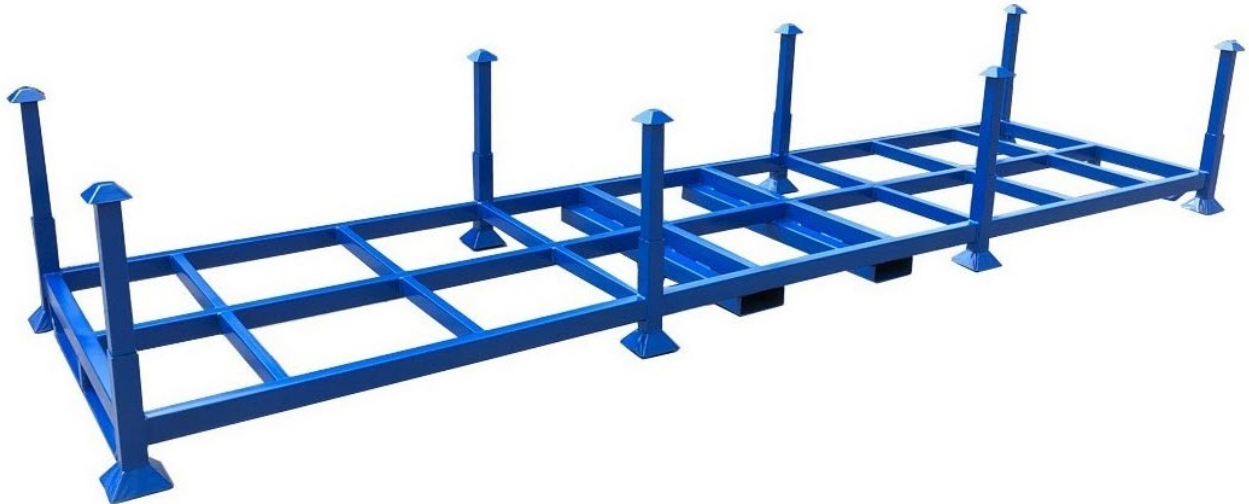

Storage Racks

LGG Part Number	LGG Part Number	Capacity	Unit Weight
10600726	48" W x 120" L x 42.25 H (37" Clear Height)	4000#	415
10600727	48" W x 216" L x 42.25 H (37" Clear Height)	2500#	457

Bauer Fittings

Note: All female couplings include rubber O-ring. All male couplings include lever ring. Sizes 2" to 8" are Bauer Type B. 10" and 12" sizes are Bauer type A.

Female Socket X Hose Shank	
LGG Part Number	Size
10426191	2"
10426189	3"
10177573	4"
10091831	6"
10322908	8"
10422675	10"
10422679	12"



Male Ball X Hose Shank	
LGG Part Number	Size
10426187	2"
10425854	3"
10222324	4"
10320889	6"
10257060	8"
10422698	10"
10422687	12"



Female Socket X 150# ASA Flange	
LGG Part Number	Size
10425776	3"
10422702	4"
10422685	6"
10422707	8"
10422673	10"
10422716	12"



Male Ball X 150# ASA Flange	
LGG Part Number	Size
10425822	3"
10422680	4"
10422689	6"
10422717	8"
10425797	10"
10425898	12"



Female Socket X Male Pipe Thread	
LGG Part Number	Size
10425852	2"
10425879	3"
10425855	4"
10422693	6"
10425793	8"



Male Ball X Male Pipe Thread	
LGG Part Number	Size
10425836*	2"
10422715	4"
10422676	6"
10422691	8"

*Lever Not Included



Reducers	
LGG Part Number	Size
10425747	3" x 2"
10425824	4" x 3"
10422694	6" x 4"
10422721	8" x 6"



Increasesers	
LGG Part Number	Size
10425863	2" x 3"
10425891	3" x 4"
10425729	4" x 6"
10425894	6" x 8"



Double Male Ball Wye	
LGG Part Number	Size
10422692	4"
10422682	6"
10422697	8"



Double Female Socket Wye	
LGG Part Number	Size
10422701	4"
10422710	6"
10422719	8"



Female Socket X Male Ball Elbow 45°	
LGG Part Number	Size
10425856	2"
10425706	3"
10422703	4"
10425732	6"
10422700	8"
10422684	10"
10426192	12"



Female Socket X Male Ball Elbow 90°	
LGG Part Number	Size
10425746	2"
10425880	3"
10422696	4"
10359404	6"
10422681	8"
10422686	10"
10422705	12"

Bauer Fittings

Note: All female couplings include rubber O-ring. All male couplings include lever ring.

Rubber O-Ring	
LGG Part Number	Size
10426188	2"
10405762	3"
10086463	4"
10027816	6"
10068310	8"
10422688	10"
10105297	12"



Lever / Ring	
LGG Part Number	Size
10426190	2"
10425728	3"
10321817	4"
10177903	6"
10303784	8"
10185587	10"
10207932	12"



Male Ball X Round Hole Strainer - Long	
LGG Part Number	Size
10422704	4"
10425844	6"
10425828	8"



Male Ball X Round Hole Strainer	
LGG Part Number	Size
10422709	10"
10422674	12"



Female Socket X Round Hole Strainer	
LGG Part Number	Size
10422708	10"
10425899	12"



Stepbow	
LGG Part Number	Size
10422706	4"
10422718	6"
10422690	8"

Strainers



Round Hole Strainer	
LGG Part Number	Size
10206406	1-1/2"
10037392	2"
10015858	2-1/2"
10153760	3"
10065303	4"
10202427	6"
10307925	8"



Long Hole Strainer	
LGG Part Number	Size
10153707	1-1/2"
10210411	2"
10253447	3"
10148415	4"



Polyethylene Strainer	
LGG Part Number	Size
10384288	1-1/2"
10285810	2"
10098433	3"



Foot Valve Painted MI	
LGG Part Number	Size
10165268	1-1/2"
10258473	2"
10267274	2-1/2"
10223303	3"
10240227	4"
10064295	6"

Grooved Fittings



STD. Rigid Coupling

LGG Part Number	Size
10600441	2"
10600397	3"
10600373	4"
10600419	6"
10600399	8"
10600374	10"
10600371	12"



STD. Flexible Coupling

LGG Part Number	Size
10600372	2"
10600433	3"
10600405	4"
10600404	6"
10600420	8"
10600355	10"
10600358	12"



HD Rigid Coupling

LGG Part Number	Size
10600342	2"
10600403	3"
10600359	4"
10600345	6"
10600392	8"
10600361	10"
10600432	12"



HD Flexible Coupling

LGG Part Number	Size
10600367	2"
10600343	3"
10600384	4"
10600386	6"
10600443	8"
10600408	10"
10600430	12"



Quick Install Coupling

LGG Part Number	Size
10600410	2"
10600414	3"
10600413	4"
10600406	6"
10600412	8"
10600352	10"
10600338	12"



Hinged Lever Coupling

LGG Part Number	Size
10600400	2"
10600354	3"
10600375	4"
10600376	6"
10600428	8"
10600370	10"



Flange Adapter

LGG Part Number	Size
10600385	2"
10600425	3"
10600426	4"
10600356	6"
10600427	8"
10600383	10"
10600429	12"



Concentric Reducer

LGG Part Number	Size
10600353	4" X 3"
10600350	6" X 3"
10600368	6" X 4"
10600337	8" X 4"
10600344	8" X 6"
10600378	12" X 6"
10600393	12" X 8"



45° Elbow

LGG Part Number	Size
10600431	2"
10600380	3"
10600365	4"
10600336	6"
10600340	8"
10600351	10"
10600382	12"



90° Elbow

LGG Part Number	Size
10600387	2"
10600366	3"
10600346	4"
10600347	6"
10600381	8"
10600379	10"
10600377	12"



Tee

LGG Part Number	Size
10600363	2"
10600364	3"
10600394	4"
10600348	6"
10600401	8"
10600341	10"
10600402	12"



Wye

LGG Part Number	Size
10600357	2"
10600424	3"
10600362	4"
10600421	6"
10600388	8"
10600389	10"
10600369	12"

Grooved Fittings



Cross

LGG Part Number	Size
10600360	2"
10600396	3"
10600395	4"
10600422	6"
10600391	8"
10600415	10"
10600416	12"



End Cap

LGG Part Number	Size
10600418	2"
10600390	3"
10600423	4"
10600434	6"
10600440	8"
10600439	10"
10600438	12"



Groove X Groove

LGG Part Number	Size
10600435	2"
10600436	3"
10600437	4"
10600339	6"
10600417	8"
10600411	10"
10600409	12"



Groove X Thread

LGG Part Number	Size
10600442	2"
10600407	3"
10600398	4"
10600349	6"

Flanged Fittings

All fittings are Class 150. Ductile iron conform to ASTM A536

Reducers

	LGG Part Number	Size
	10600677	4" x 3"
	10352692	6" x 4"
	10600679	8" x 4"
	10600680	8" x 6"

45° Elbows

	LGG Part Number	Size
	10600681	3"
	10600682	4"
	10600683	6"
	10600684	8"

90° Elbows

	LGG Part Number	Size
	10600685	3"
	10600686	4"
	10600687	6"
	10600688	8"

Tees

	LGG Part Number	Size
	10600689	3"
	10600690	4"
	10600691	6"
	10600692	8"

Many other sizes and configurations available upon request

Threaded Flanges

150# Forged NPT Threaded

	LGG Part Number	Size
	10600605	2"
	10600606	3"
	10600607	4"
	10600608	6"
	10600609	8"
	10600610	10"
	10600611	12"

Pipe Fittings

Note: All fittings are 150# black malleable iron. Additional sizes and fitting types available.



Coupling	
LGG Part Number	Size
10190050	1-1/2"
10178010	2"
10600451	2-1/2"
10099986	3"
10026354	4"
10600452	6"



45 Elbow	
LGG Part Number	Size
10255262	1-1/2"
10276576	2"
10600453	2-1/2"
10104422	3"
10145490	4"
10097949	6"



90 Elbow	
LGG Part Number	Size
10144384	1-1/2"
10258538	2"
10600454	2-1/2"
10075580	3"
10288447	4"
10167383	6"



Street Elbow	
LGG Part Number	Size
10278170	1-1/2"
10220790	2"
10350560	2-1/2"
10211217	3"
10225111	4"
10600455	6"



Tee	
LGG Part Number	Size
10285267	1-1/2"
10237084	2"
10600456	2-1/2"
10244967	3"
10304169	4"
10017621	6"



Reducing Coupling	
LGG Part Number	Size
10110512	1-1/2" X 1"
10112999	2" X 1-1/2"
10600457	2-1/2" X 2"
10176460	3" X 2"
10192695	4" X 3"
10245794	6" X 4"



Bushing	
LGG Part Number	Size
10267223	1-1/2" X 1"
10023065	2" X 1-1/2"
10231111	2-1/2" X 2"
10090546	3" X 2"
10081227	4" X 3"
10028151	6" X 4"



Union	
LGG Part Number	Size
10018430	1"
10113426	1-1/2"
10270338	2"
10064789	2-1/2"
10293797	3"
10389029	4"

Valves



Butterfly Valve Wafer Style

LGG Part Number	Size
10066622	2"
10128433	3"
10600655	4"
10035326	6"
10220172	8"
10600703	10"
10136147	12"



Butterfly Valve Lug Style

LGG Part Number	Size
10600704	2"
10090913	3"
10081033	4"
10011842	6"
10600705	8"
10177484	10"
10332996	12"



Butterfly Valve Wafer W/ Guide Holes

LGG Part Number	Size
10090701	2"
10175901	3"
10267080	4"
10311852	6"
10242589	8"
10131642	10"
10115906	12"



Butterfly Valve Wafer W/ Guide Holes

LGG Part Number	Size
10600750	2"
10600751	3"
10600752	4"
10600753	6"
10600754	8"
10600755	10"
10600756	12"



Butterfly Valve Groove X Groove

LGG Part Number	Size
10181495	2"
10600706	3"
10316976	4"
10600478	6"
10069442	8"



Swing Check Valve

LGG Part Number	Size
10600707	2"
10600708	3"
10600709	4"
10600710	6"
10600711	8"

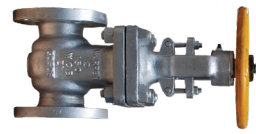

Gate Valve 150# Flanged

LGG Part Number	Size
10600719	2"
10600720	3"
10600721	4"
10600722	6"
10600723	8"
10600724	10"
10600725	12"



Knife Gate Valve 150# Lug Style

LGG Part Number	Size
10600712	2"
10600713	3"
10600714	4"
10600715	6"
10600716	8"
10600717	10"
10600718	12"

Flange Gaskets and Kits

Note: Kits contain a 150# full face or ring gasket and Grade 2 plain bolts and nuts.

Red SBR Rubber Ring		
	LGG Part Number	Size
	10506544	2"
	10506549	3"
	10506523	4"
	10506531	6"
	10506517	8"
	10506525	10"
	10506514	12"

Red SBR Rubber Full Face		
	LGG Part Number	Size
	10506526	2"
	10506543	3"
	10506545	4"
	10506532	6"
	10506533	8"
	10506519	10"
	10506527	12"

Non-Asbestos Ring		
	LGG Part Number	Size
	10506529	2"
	10506515	3"
	10506516	4"
	10506520	6"
	10506537	8"
	10506538	10"
	10506518	12"

Non-Asbestos Full Face		
	LGG Part Number	Size
	10506528	2"
	10506540	3"
	10506522	4"
	10506521	6"
	10506542	8"
	10506539	10"
	10506548	12"

Flange Gaskets and Kits

Size	SBR Red Rubber		Non-Asbestos		Neoprene	
	Ring	Full Face	Ring	Full Face	Ring	Full Face
	LGG Part Number	LGG Part Number	LGG Part Number	LGG Part Number	LGG Part Number	LGG Part Number
2"	10274507	10061268	10105413	10271544	10600745	10191630
3"	10114094	10119261	10086418	10184180	10600746	10081898
4"	10101904	10198288	10155540	10223685	10600747	10028011
6"	10166138	10006776	10004119	10236599	10201442	10271753
8"	10150868	10135681	10147074	10232742	10600748	10057654
10"	10218904	10262551	10253829	10224573	10129216	10308125
12"	10040955	10187541	10313542	10292568	10600749	10070419

Ducting - AC Dehumidification

Construction: High-strength sewn single-ply PVC vinyl-coated polyester fabric hose reinforced with a spring steel wire helix and external PVC wearstrip. Lightweight with great compressibility 6:1.

Temperature Range: -20°F to +180°F

Standard Colors: White with white wearstrip and yellow with black wearstrip

Size Range: 12" to 24" (other sizes available)

Standard Length: 25 Feet

Ends Available: Wire rope/nylon ring, standard/enclosed belted cuff, sewn cuff, funnel cuff, belt loop and pull tab

Note: The below items come standard with wire rope ends. Other ends and colors are also available. Contact your LGG Industrial Location for other options available.



LGG Part Number	Hose Size	Pitch	Color / Wearstrip Color	End Finishes	Max Temp
10394806	8" x 25'	4" pitch	White/White	Wire Rope	180°F
10394977	10" x 25'	6" pitch	White/White	Wire Rope	180°F
10276247	12" x 25'	6" pitch	White/White	Wire Rope	180°F
10286605	14" x 25'	6" pitch	White/White	Wire Rope	180°F
10417183	16" x 25'	6" pitch	White/White	Wire Rope	180°F
10251569	20" x 25'	6" pitch	White/White	Wire Rope	180°F
10425823	24" x 25'	6" pitch	White/White	Wire Rope	180°F
10317553	20" x 25'	6" pitch	Yellow/Black	Wire Rope	180°F



Return Duct

LGG Part Number	Hose Size	Pitch	Color / Wearstrip Color	End Finishes	Max Temp
10227941	20" x 25'	4" pitch	Blue/Black	Wire Rope	180°F
10417799	20" x 25'	4" pitch	White/White	Wire Rope	180°F



Ducting – AC Dehumidification Accessories

WYEs with wire rope ends – available in different configurations.

LGG Part Number	Size	Color	End Finishes	Max Temp
10211687	12" x 12" x 12"	White	Wire Rope	180°F
10189044	20" x 12" x 12"	White	Wire Rope	180°F
10417800	20" x 14" x 14"	White	Wire Rope	180°F
10060837	20" x 20" x 20"	White	Wire Rope	180°F



Ceiling Tiles only available in 12", 16" & 20" IDs

LGG Part Number	Size	Color	Package Quantity	Pallet Quantity
10058442	24" x 24" x 12"	White*	7 ea/box	84 ea/pallet
10417797	24" x 24" x 16"	White*	7 ea/box	84 ea/pallet
10417801	24" x 24" x 20"	White	7 ea/box	84 ea/pallet



Ceiling Tile Hose Kit comes with 8' lengths of FSP-5 ducting white with no wearstrip and belted cuffs on each end

LGG Part Number	Hose Size	Tile Size	Color	Pallet Quantity
10319368	12" x 8'	24" x 24"	White	36 ea/pallet
10417804	16" x 8'	24" x 24"	White	84 ea/pallet
10417814	20" x 8'	24" x 24"	White	84 ea/pallet



Ducting – Heater

Construction: High-strength sewn single-ply urethane-coated polyester fabric hose reinforced with a spring steel wire helix and external PVC wearstrip. Lightweight with great compressibility of 6:1; urethane coating for increased puncture, abrasion, and tear resistance. Chemical, fuel, and oil resistant.

Temperature Range: -60°F to +400°F

Standard Colors: Black with black wearstrip and black with orange wearstrip

Size Range: 12" to 24" (other sizes available)

Standard Length: 25 Feet

Ends Available: Wire rope/nylon ring, standard/enclosed belted cuff, sewn cuff, funnel cuff, belt loop and pull tab

Note: The below items come standard with wire rope ends. Other ends and colors are also available. Contact your LGG Industrial Location for other options available.



LGG Part Number	Hose Size	Pitch	Color / Wearstrip Color	End Finishes	Max Temp
10331773	12" x 25'	6" pitch	Black/Black	Wire Rope	400°F
10224699	16" x 25'	6" pitch	Black/Black	Wire Rope	400°F
10147147	20" x 25'	6" pitch	Black/Black	Wire Rope	400°F
10425803	24" x 25'	6" pitch	Black/Black	Wire Rope	400°F



Ducting – Heater

WYEs with wire rope ends – available in different configurations

LGG Part Number	Size	Color	End Finishes	Max Temp
10200492	20" x 20" x 20"	Black	Wire Rope	400°F
10258212	20" x 12" x 12"	Black	Wire Rope	400°F
10040033	12" x 12" x 12"	Black	Wire Rope	400°F



Ducting – Heater High-Temperature

Construction: High-strength sewn single-ply heavy-duty silicone-coated fiberglass fabric hose reinforced with a spring steel wire helix and external wearstrip. Lightweight with great compressibility of 6:1; great puncture and tear resistance.

Temperature Range: -50°F to +550°F

Standard Colors: Silver with black wearstrip

Size Range: 12" to 24" (other sizes available)

Standard Length: 25 Feet

Ends Available: Wire rope/nylon ring and enclosed belted cuff

Note: The below items come standard with wire rope ends. Other ends and colors are also available. Contact your LGG Industrial Location for other options available.



Wire Rope/Nylon Ring



Standard/Enclosed Belted Cuff

LGG Part Number	Hose Size	Pitch	Color / Wearstrip Color	End Finishes	Max Temp
10417811	12" x 25'	6" pitch	Silver/Black	Wire Rope	550°F
10417807	16" x 25'	6" pitch	Silver/Black	Wire Rope	550°F
10425772	20" x 25'	6" pitch	Silver/Black	Wire Rope	550°F
10425780	24" x 25'	6" pitch	Silver/Black	Wire Rope	550°F



Ducting – Lay Flat Poly

Description: 33" x 500' x .006 thick – material is LDPE + LLDPE – 20 rolls per skid

Standard Length: 500-foot rolls

LGG Part Number	Size	Color	Thickness
10306439	20" x 500'	Clear	6 mil
10110434	16" x 500'	Clear	6 mil
10267937	12" x 500'	Clear	6 mil
10417808	20" x 500'	White	6 mil



Hydraulic Hose, Fittings, and Adapters

LGG Industrial offers a wide range of hydraulic hose and fittings to cover every field application requirement including:

- SAE100R13:** 1/4" – 2", four or six spiral. High-pressure hydraulic hose. Working pressures to 5100 psi.
- SAE100R2AT:** 1/4" – 2", two wire braids. High-pressure hydraulic hose. Working pressures to 6,500 psi.
- SAE100R5:** 1/4" – 2-1/2", one wire braid. Working pressures to 3,000 psi. Polyester braided cover.
- SAE100R16:** 1/4" – 2", two wire braids. High-pressure hydraulic hose. Working pressures to 6,500 psi. Exceeds EN requirements at half (1/2) the bend radius.
- 2SN:** 1/4" – 2" (EN 853) two wire braids. High-pressure hydraulic hose. Working pressures to 6,500 psi.
- SAE100R12:** 1/4" – 2" inch, four spiral. High-pressure hydraulic hose. Working pressures to 6,500 psi.
- Fittings:** The full range of JIC, male pipe, code 61, and code 62, as well as other high-pressure hydraulic hose fittings.



Hydraulic Crimpers and Accessories

LGG Industrial has a full crimper program available along with a full range of accessories including crimpers, dies, pumps, hose racks, hose saws, die racks, and much more.



Hydraulic Mobile Crimper

LGG Industrial is able to offer a unique mobile crimper solution. The crimper can be mounted in your trucks so that you can easily crimp hoses on the go. The crimper is designed so that it can tilt out when it's time to crimp. This means that the crimper does not need to be unloaded from the truck when it's time to crimp. This allows for quicker assembly and provides a safer work environment by avoiding lifting and moving a heavy crimper. There is also storage underneath for you to hold your dies and accessories providing a an easier crimping experience.



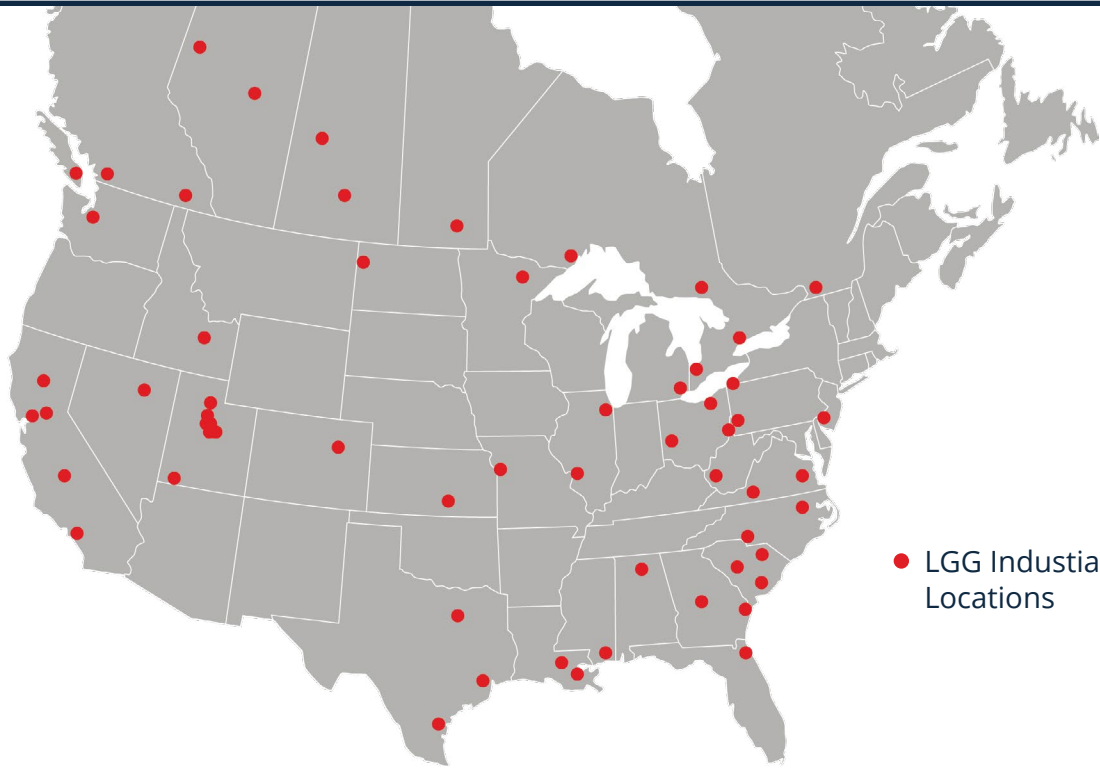

● LGG Industrial Locations

Other Rental Industry Products & Solutions



Conveyor Belts

- Asphalt belt
- OEM replacement belt
- Sand belt



Expansion Joints

- Rubber spool-type expansion joints
- Flue duct joints ducting systems – round/rectangular
- Metal expansion joints

ONE OF OUR
LARGER RENTAL CUSTOMERS
COMMENTED

“I can’t say enough good things about dealing with LGG Industrial; it’s always an easy order/test process. One call or email and all is taken care of. When you’re busy, that makes a tremendous difference.”



LGG INDUSTRIAL

lggindustrial.com